

Embedded RISC PC PNP/1110 Starter Kit

User Manual

Contents

1. INTRODUCTION	5
1.1 Conventions used in this Document	5
1.2 Checklist	5
1.3 Features	6
2. BOARD LAYOUT	7
3. BOARD COMPONENTS	8
3.1 PGA Socket (Socket 3)	8
3.2 Power Connector	8
3.3 Power LED	9
3.4 Output LEDs	9
3.5 DIP Switches	9
3.6 Reset Button	9
3.7 Prototype Area	9
3.8 RCM Jumper	10
3.9 JTAG Interface	10
3.10 10/100Mbps Ethernet Interface	10
3.11 Serial Interface COM1	10
3.12 Serial Interface COM2	10
3.13 COM2 Power Switch (JP2)	11
3.14 LCD Interface	11
3.15 CFL Interface	11
3.16 Interrupt Usage	11
4. CONNECTIONS	12
4.1 Mounting the PNP/1110	12
4.2 Cable Connections	13
4.2.1 Serial Link	13
4.2.2 Ethernet Link	14
4.2.3 Power Supply	14
4.2.4 LC-Display	15
5. FIRST STEPS	16
5.1 Using a Windows-based development System	16
5.1.1 Setup the Serial Link	16
5.1.2 Checking the Ethernet Link	18
5.1.3 Web Server Access	19

5.1.4	Login via Serial Console	20
5.1.5	Login via Telnet.....	21
5.1.6	File Transfer via FTP	21
5.1.7	Embedded Linux Maintenance	23
5.1.8	Embedded Linux Maintenance via HyperTerminal/Serial Link.....	24
5.2	Using a Linux–based development System	25
5.2.1	Setup the Serial Link.....	25
5.2.2	Checking the Ethernet Link.....	27
5.2.3	Web Server Access	28
5.2.4	Login via Serial Console	29
5.2.5	Login via Telnet.....	29
5.2.6	File Transfer via FTP	30
5.2.7	Embedded Linux Maintenance	32
5.2.8	Embedded Linux Maintenance via Minicom/Serial Link	32
5.2.9	Installation of the GNU Cross Toolchain.....	35
6.	TROUBLESHOOTING	40
7.	APPENDIX	41
	Appendix 1: Pin Assignment PNP/1110	41
	Appendix 2: Pin Assignment DNP/EVA4 Components	47
	CFL Connector.....	47
	LCD Connector.....	47
	COM1 Connector	48
	COM2 Connector	48
	10/100 Mbps Ethernet Connector	48
	JTAG Connector	49
	Power Connector.....	49
	RCM Jumper.....	49
	COM2 Power Switch Jumper JP2.....	49
	Appendix 3: PNP/1110 Memory Map	50
	Appendix 4: DIP-Switch Settings	50
	Appendix 5: Interrupt Usage	51
	Appendix 6: The RCME (RCM Enable) Jumper.....	52
	Appendix 7: The PNP/1110 Clock Output.....	52
	Appendix 8: Using the SA-1110 Serial Channels.....	53
	Appendix 9: Using the Compact Flash (CF)-Interface	54
	Appendix 10: Mechanical Dimensions	57
	Appendix 11: GNU General Public License	58
	Appendix 12: GNU Lesser General Public License	63
	List of Figures.....	71

List of Tables72

List of Appendixes73

Contact.....74

Document History74

1. Introduction

Thank you for choosing an SSV Starter Kit. We are confident that you will be pleased with the performance of your product. Please take a few minutes to read this manual. It describes how to start with the DNP/SK6 Starter Kit and will help you to get out the most of your new system.

For further information about the individual components of this Starter Kit you may follow the links from our website at: <http://www.dilnetpc.com>

Our Website contains a lot of technical information, which will be updated in regular periods.

For specific technical information – like hardware description etc. – please check out the Starter Kit CD-ROM, which is an important part of every Starter Kit.

1.1 Conventions used in this Document

Convention	Usage
<i>italic</i>	Filenames, as well as Internet addresses such as www.ssv-embedded.de
<i>italic</i>	User inputs, command lines and pathnames
bold	New terms
monospace text	Program code

Table 1: Convention usage

1.2 Checklist

Compare the contents of your Starter Kit package with the standard checklist below. If any item is missing or appears to be damaged, please contact SSV Embedded Systems.

Standard Items

- √ Evaluation Board DNP/EVA4
- √ Embedded RISC PC PNP/1110
- √ LC-Display
- √ LC-Display Data Cable
- √ CFL Power Cable
- √ Backlight Converter (Inverter)
- √ Power Supply
- √ Power Cable
- √ User Manual
- √ Support CD-ROM

1.3 Features

Evaluation Board DNP/EVA4

- 237-pin ZIF-PGA socket (Socket 3) for one Embedded RISC PC PNP/1110
- LCD-Interface
- CFL-Power Output
- Two RS232 Serial Interfaces
- 10/100Mbps Ethernet Interface
- Eight User-Definable LEDs
- Six Manual DIP Switches
- One Reset Switch
- Prototype-Area
- 5 VDC Power Input Connector
- Null-Modemcable
- Size 210 x 148 mm

Embedded RISC PC PNP/1110

- Intel StrongARM SA-1110 CPU with 206 MHz Clock Speed
- 64 MByte SDRAM Memory, 16 MByte FLASH Memory
- LCD-Interface (TFT and passive LCD)
- 10/100Mbps Ethernet Interface
- PCMCIA dedicated Pins
- Real Time Clock
- Two 16C550 UART Serial Ports
- 18-bit General Purpose High-Speed Parallel I/O
- 32-bit I/O Expansion Bus
- 5 Interrupt Inputs, 5 Chip Select Outputs
- In-System Programming Features
- 169-pin JEDEC PGA-Connector
- 3.3 Volt Low Power Design, Single 3.3 VDC Supply
- Supply Current to be defined
- Size 45 x 45 mm

2. Board Layout

The main component of the Starter Kit is the Evaluation Board DNP/EVA4. On this board you will find a 237-pin ZIF-PGA socket (ZIF = Zero Insertation Force) to mount your 169-pin PNP/1110.

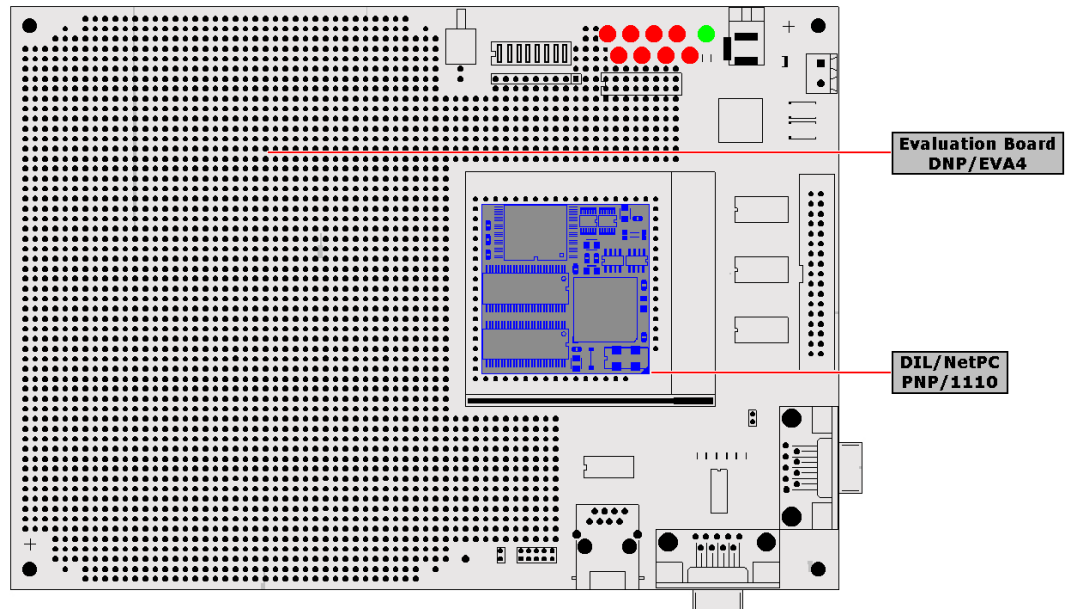

Figure 1: Evaluation Board EVA4 with PNP/1110

The Starter Kit DNP/SK6 provides all required basic hard- and software environment, which allows you the development of individual applications for your PNP/1110. For an instant connection to your hardware the Evaluation Board supports two serial COM interfaces, a 10/100Mbps Ethernet interface as well as a PGA (Socket 3) interface. Further you will find a prototype (wire-wrap) area, eight LEDs, eight DIP-switches (six occupied and two not connected) and one reset switch, which allows you to test your peripheral applications very easy. With the prototype area you have an ideal place to install and test your own applications on the Evaluation Board. The LC-Display, which is added as supplement to the Starter Kit allows an easy visualizing of your work.

3. Board Components

This chapter describes the most interesting components of the Evaluation Board DNP/EVA4 and gives a short overview about their respective functions.

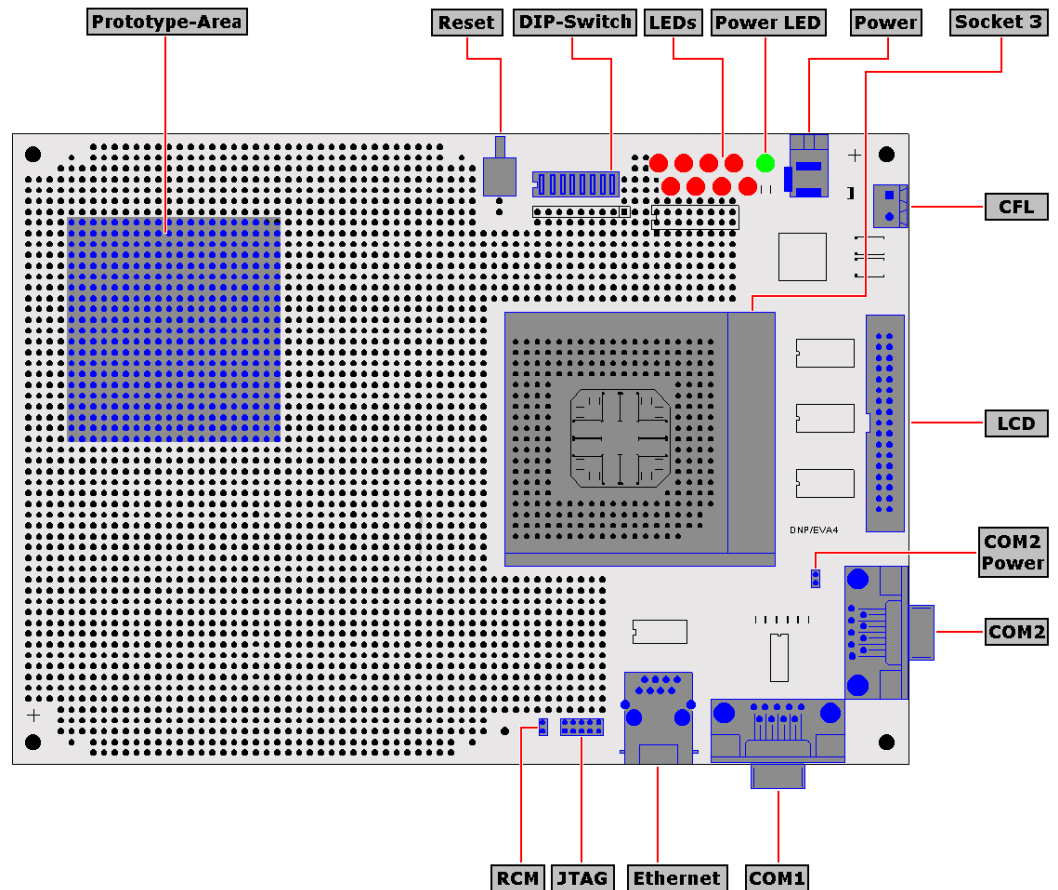

Figure 2: Main components of the Evaluation Board DNP/EVA4

3.1 PGA Socket (Socket 3)

The Evaluation Board offers a single 237-pin ZIF-PGA socket (PGA = Pin-Grid-Array) also known as Socket 3. This socket picks up your 169-pin PNP/1110 and builds the interface to the individual parts on the Evaluation Board.

3.2 Power Connector

The Power connector onto the Evaluation Board has to be connected with the power supply, which is added to your Starter Kit. Alternatively you are able to use a similar power supply that provides +5V DC and about 2A current.

3.3 Power LED

The Evaluation Board DNP/EVA4 is equipped with a single green LED. This LED will light up when the board is provided with the necessary operating voltage.

3.4 Output LEDs

The Evaluation Board provides eight red LEDs for testing purposes. These LEDs are the first little application for the PIO-Ports. The LEDs will flicker or light up to indicate traffic on the output ports PB0–PB7.

3.5 DIP Switches

The Evaluation Board has a set of eight DIP-switches. Six of these switches are allocated with functions; two of them are not connected. The DIP-switches give you the possibility to put 6-bit binary numbers to the input ports PA0–PA5. The DIP-switches are the second little application for the PIO ports.

Switch open = Signal V_{in} Low (GND)

Switch closed = Signal V_{in} High (V_{cc})

The DIP-switches are also used as strap-option for the LC-Display resolution and color. For the available LC-Display settings please see chapter 4.2.4. After the bootstrap is finished these switches can be used free.

3.6 Reset Button

Next to the DIP-Switches you find the Reset button. Press it down if the system hang or you want to restart it. Pressing the Reset button will only restart the PNP/1110. To reset any connected devices–like a LC-Display etc–turn off power from the system.

3.7 Prototype Area

The Prototype Area offers space to develop your own applications and circuits on the Evaluation Board.

3.8 RCM Jumper

Use this jumper to activate the RCM mode of the PNP/1110. To activate the RCM mode place a jumper cap on both pins of the RCM jumper, so that it is short. If you remove the jumper cap, or place the jumper cap on just one pin, the jumper is open and you are not able to use the RCM mode. When closed, you will see some boot messages on the serial port COM1. If the RCM jumper is not set, these messages will be blocked by the system. Please see Appendix 6 for more information.

3.9 JTAG Interface

The Evaluation Board DNP/EVA4 is equipped with a 10-pin JTAG connector. This connector is for factory service only. Please do not touch—the system may be damaged. Please contact SSV Embedded Systems for more information.

3.10 10/100Mbps Ethernet Interface

The PNP/1110 is using a SMSC LAN91C111 chip that allows Ethernet connectivity with a speed up to 100Mbps. The RJ45 Ethernet interface on the Evaluation Board is just a simple connection over a transformer to the PGA interface pins, which are connected to the SMSC LAN controller on the PNP/1110.

3.11 Serial Interface COM1

For an easy connection between the Starter Kit and your development system you can use the serial interface COM1. The COM1 interface is realized as a RS232 standard compliant Sub-D port with 9 pins. The exact layout of the COM1 interface is shown in Appendix 2.

3.12 Serial Interface COM2

The COM2 interface on the Evaluation Board DNP/EVA4 is realized as a RS232 standard compliant Sub-D port with 9 pins. The exact layout of the COM2 interface is shown in Appendix 2.

You have the possibility to switch power to the pins 4 and 7 by closing the COM2 power switch jumper JP2. This feature may be used to supply a connected device like a touch screen or mouse.

3.13 COM2 Power Switch (JP2)

You can use the COM2 port to connect a serial device like a mouse or touch screen. These devices normally need a power supply to work correctly. By closing the jumper JP2 (place a jumper cap on both pins) the pins 4 and 7 of the COM2 Sub-D connector will be connected with main power (5V). If jumper JP2 is left open the pins 4 and 7 of COM2 become not connected.

3.14 LCD Interface

This interface offers all necessary signals to use several types of LC-Displays. Please plug the data cable of the LC-Display to the LCD interface on the Evaluation Board. Please make sure that you have the pin-1 side of the cable matched with the pin-1 side of the connector. The LCD interface on the Evaluation Board is able to run active as well as passive LC-Displays.

Note: If you want to connect a different display than the supplied, please contact SSV Embedded Systems for more information.

3.15 CFL Interface

To provide the affiliated LC-Display with the necessary extra voltage for the backlight there is a CFL interface available on the DNP/EVA4. The extra voltage comes from an external backlight converter (inverter), which is part of the Starter Kit. See Chapter 5.4 for more information about the correct connection between the LC-Display and the DNP/EVA4. To avoid capacity loss the backlight converter should be placed nearby the LC-Display.

3.16 Interrupt Usage

The PNP/1110 supports up to five interrupt lines. One of them is exclusively available in all display modes. The interrupt 2-5 are multiplexed (this means that the pins on the interface are shared with another device) with the LCD data lines 12-15. If you want to use up to five interrupts, only specific LC-Displays can be used. For more information see Appendix 5.

4. Connections

For a quick and easy start with the DNP/SK6 Starter Kit there are several connections necessary. The following chapter describes, how and between which components these connections have to be made.

4.1 Mounting the PNP/1110

To mount the PNP/1110 on the Evaluation Board DNP/EVA4 pull the locking lever away from the socket to unhook it and then raise the locking lever to the downright position. Now identify the pin-1 corner on the socket and the pin-1 corner on the PNP/1110. The socket pin-1 corner is adjacent to the handle of the locking lever. On the PNP/1110 a white sign marks the pin-1 corner. Matching the pin-1 corners, drop the PNP/1110 down into the socket. No force is required and the PNP/1110 should seat easily into the socket. After that, swing the locking lever down and hook it under the latch on the edge of the socket. This locks the PNP/1110 in place.

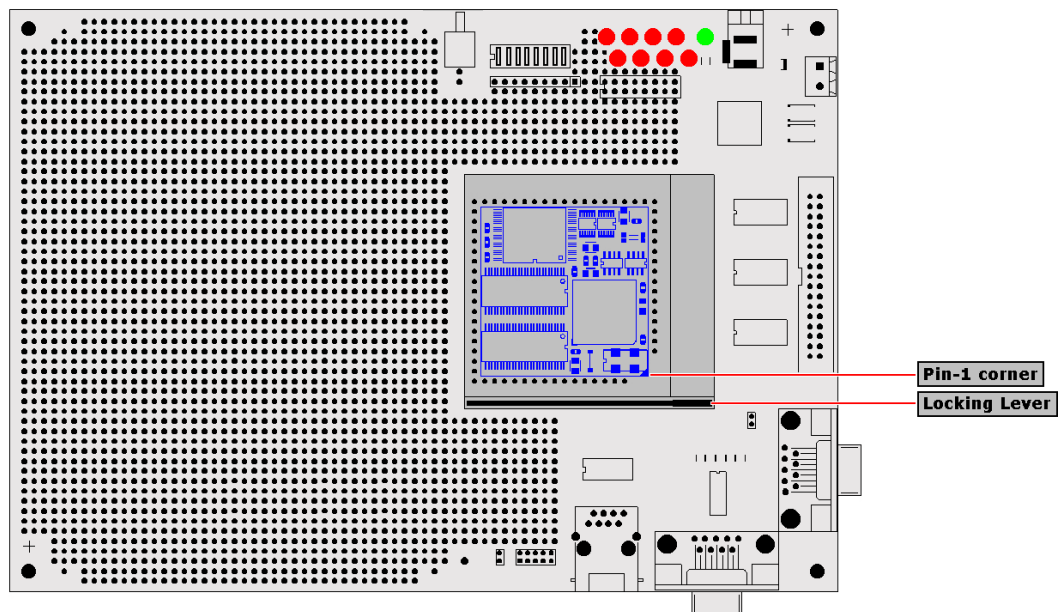

Figure 3: Position of the DIL/NetPC on the Evaluation Board

4.2 Cable Connections

Before you can use your DIL/NetPC Starter Kit you need a further Desktop- or Notebook-PC, which acts as development system. This development system should run under MS-Windows or Linux in an ideal manner. Between the development system and the Starter Kit are two connections required. At first the **RS232 Serial Link** and at second the **Ethernet Link**. The PC will act as development system and as **Remote Console Monitor (RCM)** for the PNP/1110 on the Evaluation Board.

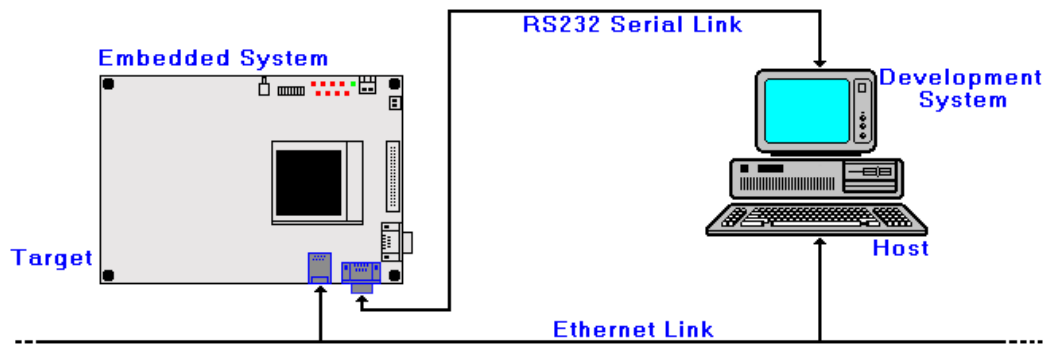

Figure 4: Overview about the required cable Connections

4.2.1 Serial Link

For the Serial Link, you need a Null-Modemcable. This cable comes along with your Starter Kit. Please connect the Evaluation Board with the COM1 port of your development system by using this cable.

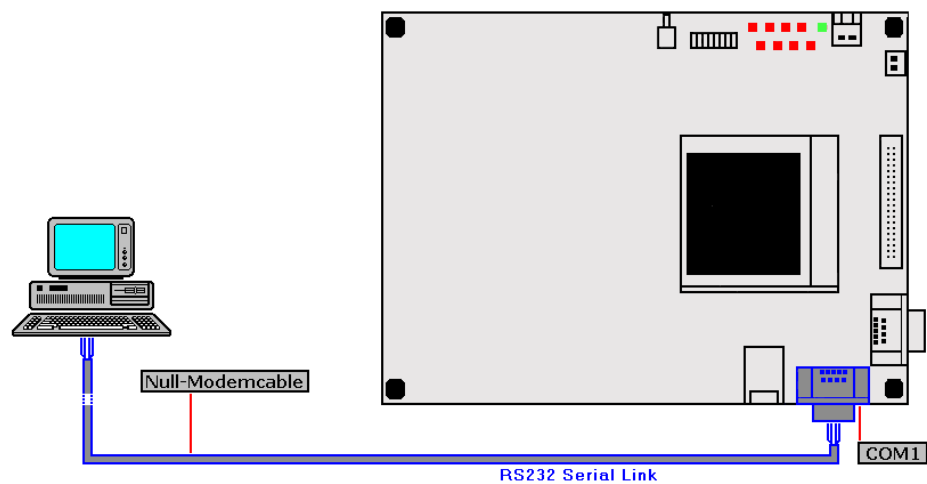

Figure 5: Serial Link Connection

4.2.2 Ethernet Link

The Ethernet Link requires two standard 10Base-T patch cables, one Hub or Switch and an Ethernet-LAN interface for your development system.

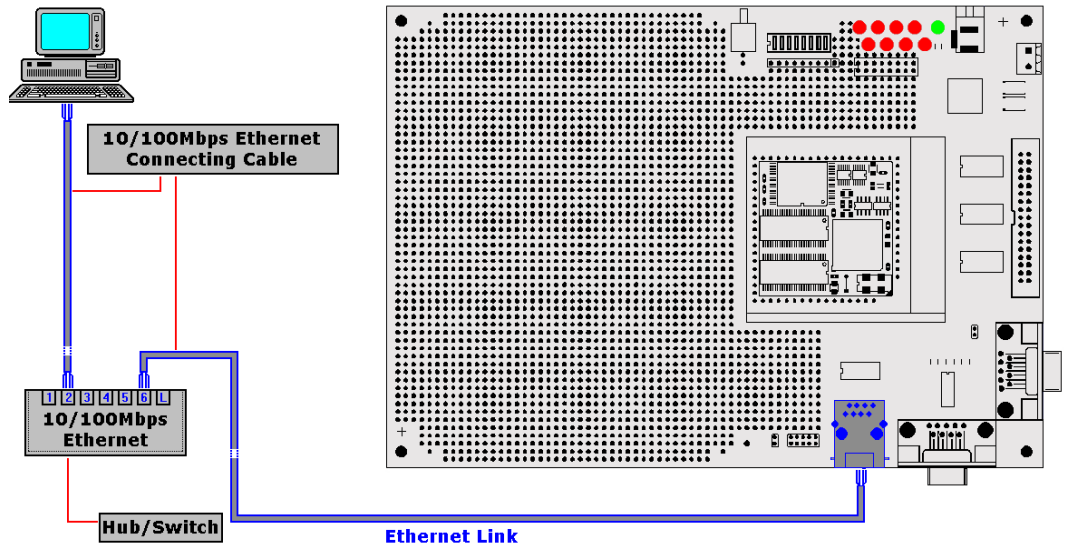

Figure 6: Ethernet Link Connection

4.2.3 Power Supply

The PNP/1110 Starter Kit needs a supply voltage of 5VDC to work. In your Starter Kit package you will find a plug-in power supply unit to provide system and LC-Display with the necessary power. After the connection of all cables the Starter Kit is ready to run.

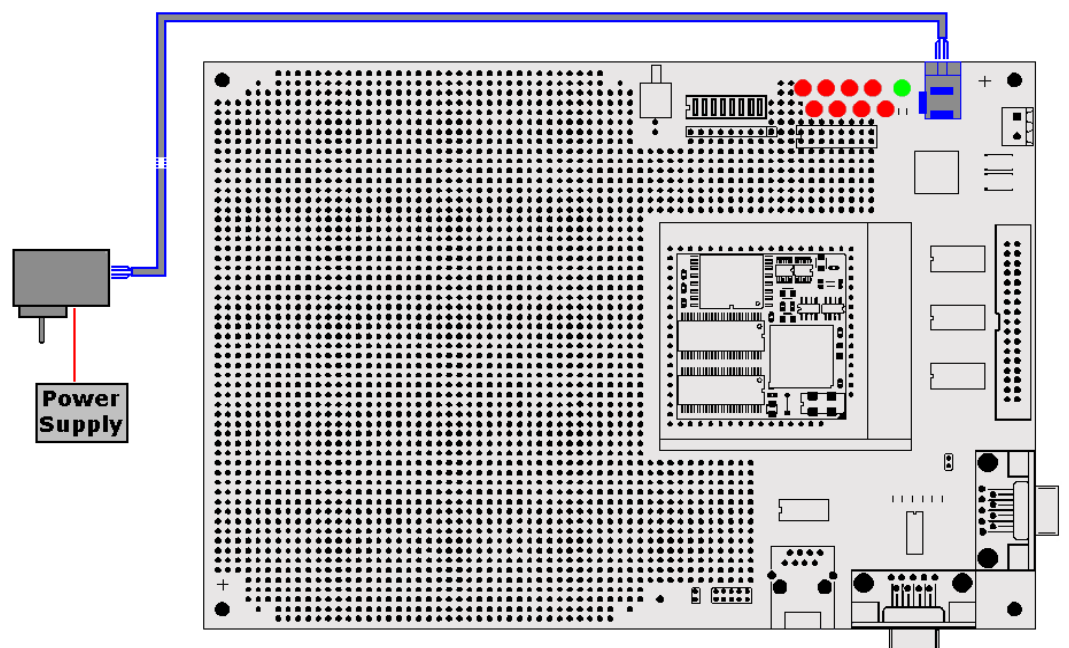

Figure 7: Power supply Connection

4.2.4 LC-Display

The Evaluation Board is ready to be connected with an LC-Display up to 800x600-pixel for the use of embedded GUI applications. To connect such a LC-Display to your system you have to disconnect power from your system.

One side of the CFL power cable should be connected with the supplied backlight converter (Inverter). After this, connect the two CFL backlight lamp cables from the LC-Display with the designated connectors on the backlight converter.

Now plug one side of the LC-Display interface cable into the LCD connector on the backside of the LC-Display. Connect the other side of the cable with the LCD connector (J6) on the Evaluation Board. Make sure, that you have the pin-1 side of the cable matched with the pin-1 side of the connectors.

Then connect the other end of the CFL power cable with the CFL connector (J7) on the Evaluation Board. Please take notice about the correct polarization. The yellow/orange pair of the wires is +, the brown/red pair is –.

Within the first seconds after power-up the LCD controller output lines are in an undefined state. If you see some lines on the display this is no error. Please wait a few seconds and the picture will turn up.

Note: The CFL connector only provides power for 5V backlight converter. Do not connect any other converter to this connector. Otherwise the system may be damaged. The LCD connector provides 3.3V/600mA to the LC-Display. The default resolution of the Starter Kit LC-Display is set to 640x480x16 bit but the Software image inside the PNP/1110 is also prepared to support some different resolutions and colors. You can change the settings for resolution and color by using the DIP-switches on the Evaluation Board. For the exact settings see Appendix 4: DIP-Switch Settings. To use other displays or resolutions as described, please contact SSV Embedded Systems.

Do not touch the CFL backlight converter (Inverter) when there is power on the system. There is high voltage on the converter unit.

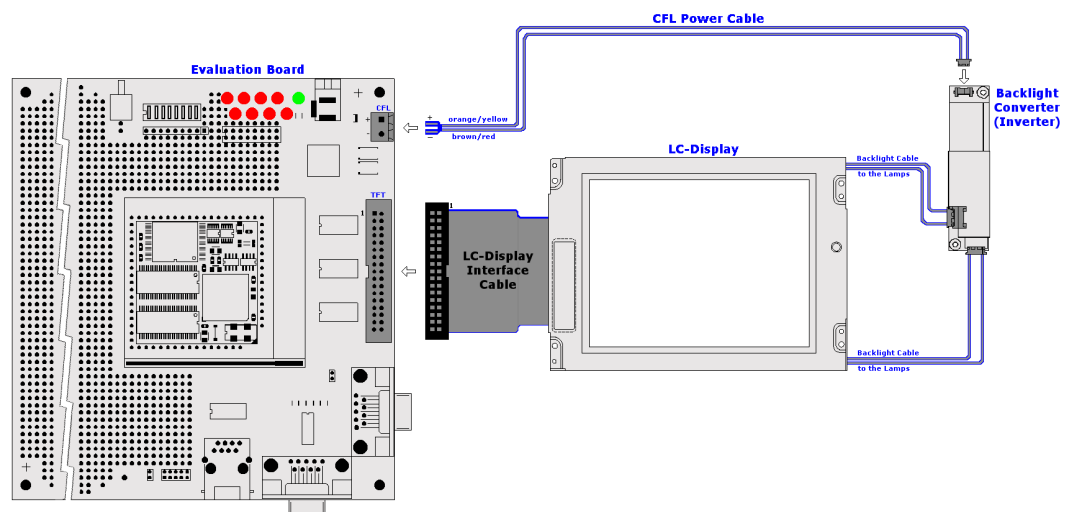

Figure 8: LC-Display Connection

5. First Steps

You can use the PNP/1110 Starter Kit from your development system. This development system may run under different operating systems. The first steps for getting started we describe exemplarily by the two most popular operating systems – MS-Windows and Linux.

5.1 Using a Windows–based development System

The following paragraphs will help you to use the PNP/1110 with a development system running under MS-Windows. For these steps some programs are necessary, which normally come along with every MS-Windows installation (e.g. HyperTerminal). Please make sure that these programs are present on your development system. If these programs are not installed at your development system – you have to install these programs manually from your MS-Windows installation CD-ROM.

5.1.1 Setup the Serial Link

Before you provide the Evaluation Board with power for the first time, please run a terminal program – for example Windows HyperTerminal – that offers communication capabilities on your development system. In the following you will see the necessary settings for HyperTerminal under Windows. Select the "direct link cable connection via COM1" interface in the property sheet and choose "Configure".

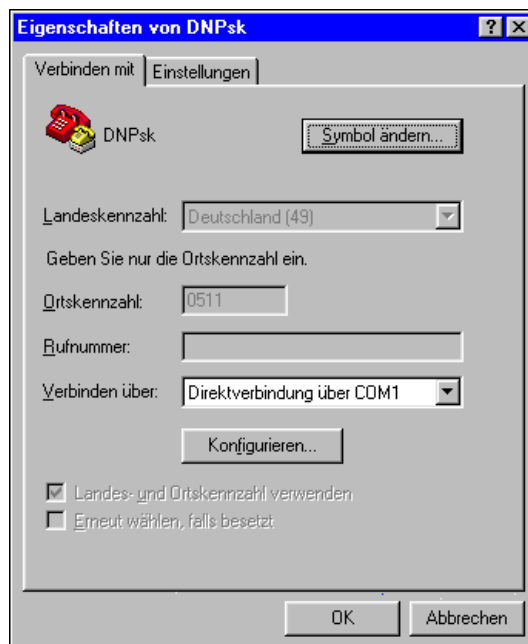

Figure 9: Interface property Sheet

Now you can change some configuration parameters – such as the maximum baud rate – on a further property sheet. Select the value "115.200" in the "Bits per Second" field and close the property sheet by clicking the "OK" button, as shown in figure 10.

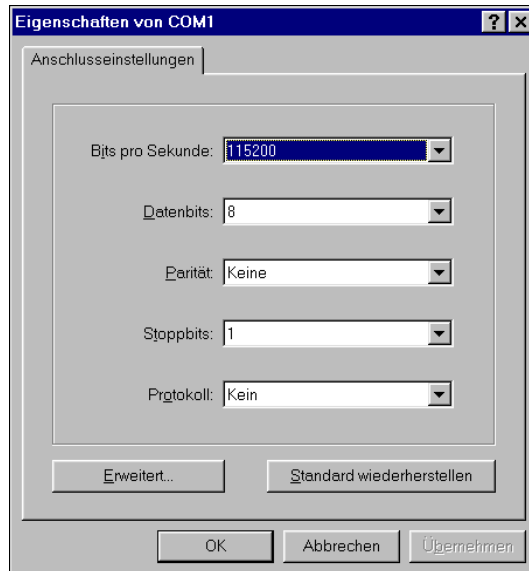
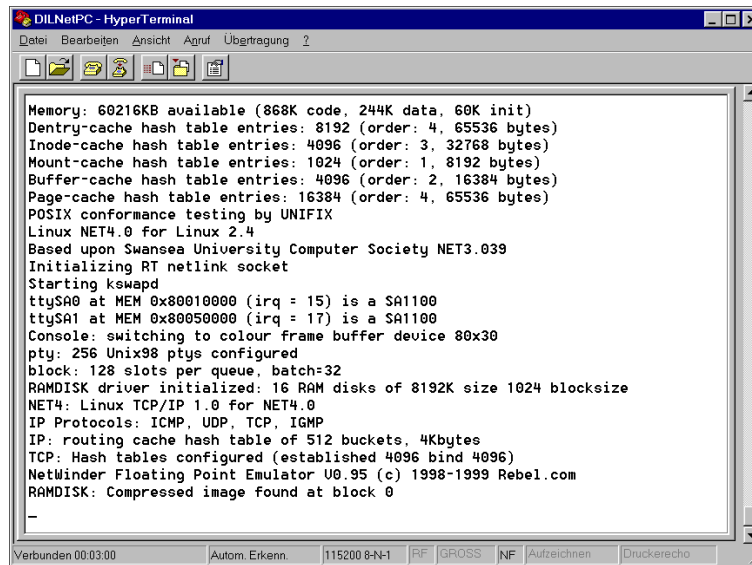

Figure 10: Baud rate Settings

All these settings can also be used for other terminal programs. The following parameters are important to use:

- Connection Speed 115.200 bps (Bits per Second)
- 8 Data bits
- No Parity bit
- 1 Stop bit
- No Protocol (Xon/Xoff, RTS/CTS or similar).

Now turn on the power for the Evaluation Board and you will see all steps of the PNP/1110 boot process in the terminal program window at your PC.



```

DILNetPC - HyperTerminal
Datei Bearbeiten Ansicht Agruf Übertragung ?
Memory: 69216KB available (868K code, 244K data, 60K init)
Dentry-cache hash table entries: 8192 (order: 4, 65536 bytes)
Inode-cache hash table entries: 4096 (order: 3, 32768 bytes)
Mount-cache hash table entries: 1024 (order: 1, 8192 bytes)
Buffer-cache hash table entries: 4096 (order: 2, 16384 bytes)
Page-cache hash table entries: 16384 (order: 4, 65536 bytes)
POSIX conformance testing by UNIFIX
Linux NET4.0 for Linux 2.4
Based upon Swansea University Computer Society NET3.039
Initializing RT netlink socket
Starting kswapd
ttyS00 at MEM 0x80010000 (irq = 15) is a SA1100
ttyS01 at MEM 0x80050000 (irq = 17) is a SA1100
Console: switching to colour frame buffer device 80x30
pty: 256 Unix98 ptys configured
block: 128 slots per queue, batch=32
RAMDISK driver initialized: 16 RAM disks of 8192K size 1024 blocksize
NET4: Linux TCP/IP 1.0 for NET4.0
IP Protocols: ICMP, UDP, TCP, IGMP
IP: routing cache hash table of 512 buckets, 4Kbytes
TCP: Hash tables configured (established 4096 bind 4096)
NetWinder Floating Point Emulator V0.95 (c) 1998-1999 Rebel.com
RAMDISK: Compressed image found at block 0
-
Verbunden 00:03:00 Autom Erkenn. 115200 8-N-1 PF GROSS NF Aufzeichnen Druckerecho

```

Figure 11: DIL/NetPC boot Process

For a first test of the PNP/1110 you have to change the assigned IP-address of your development system to "192.168.0.1". To change the IP-address under MS-Windows just click "Start→Settings→Control Panel→Network→TCP/IP" and enter the new IP-address. Please make sure, that you don't use another IP-address – this will lead to different network problems.

5.1.2 Checking the Ethernet Link

To test the TCP/IP-communication we use **PING** a very popular TCP/IP-utility program. Please open a DOS window (you can find it in the Windows Start menu) and enter:

ping 192.168.0.126.

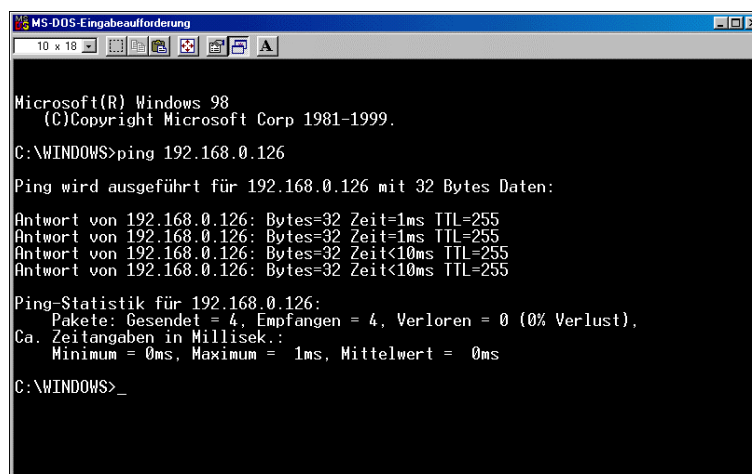

```

MS-DOS-Eingabeaufforderung
10 x 18
Microsoft(R) Windows 98
(C)Copyright Microsoft Corp 1981-1999.
C:\WINDOWS>ping 192.168.0.126
Ping wird ausgeführt für 192.168.0.126 mit 32 Bytes Daten:
Antwort von 192.168.0.126: Bytes=32 Zeit=1ms TTL=255
Antwort von 192.168.0.126: Bytes=32 Zeit=1ms TTL=255
Antwort von 192.168.0.126: Bytes=32 Zeit<10ms TTL=255
Antwort von 192.168.0.126: Bytes=32 Zeit<10ms TTL=255
Ping-Statistik für 192.168.0.126:
Pakete: Gesendet = 4, Empfangen = 4, Verloren = 0 (0% Verlust),
Ca. Zeitangaben in Millisek.:
Minimum = 0ms, Maximum = 1ms, Mittelwert = 0ms
C:\WINDOWS>_

```

Figure 12: Communication check via PING

The Starter Kit must answer this ping. Otherwise an error will occur. In this case you have to check all parts of your LAN-connection, including the IP-address of the development system. Then you should find out if the IP-address is set correctly to the value "192.168.0.1". For an easy check of the IP-address, you can use the following DOS-command:

Ipconfig

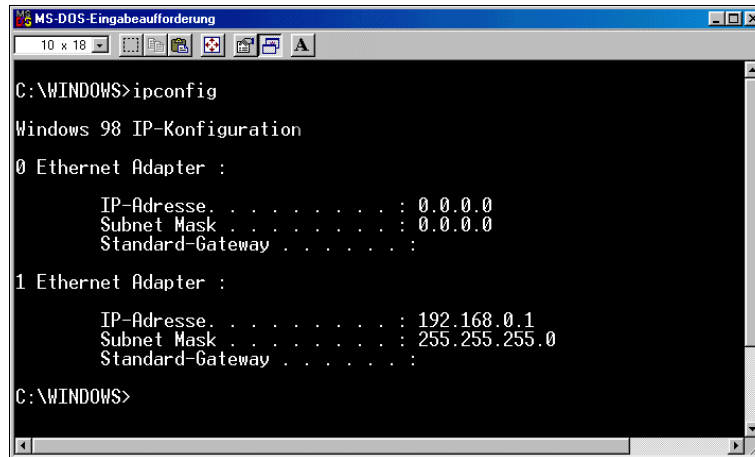

```

C:\WINDOWS>ipconfig

Windows 98 IP-Konfiguration

0 Ethernet Adapter :

    IP-Adresse. . . . . : 0.0.0.0
    Subnet Mask . . . . . : 0.0.0.0
    Standard-Gateway . . . . . :

1 Ethernet Adapter :

    IP-Adresse. . . . . : 192.168.0.1
    Subnet Mask . . . . . : 255.255.255.0
    Standard-Gateway . . . . . :

C:\WINDOWS>

```

Figure 13: Communication check via ipconfig command

Once the ping was successful, you are ready to start a Web browser on your development PC. This browser can be the Microsoft Internet Explorer or another suitable Web browser like the Netscape Communicator or Opera or similar.

5.1.3 Web Server Access

Open the URL <http://192.168.0.126/index.htm>. The Embedded Web Server will deliver you a small description about the PNP/1110. That's it. Now you are online with the Starter Kit and your Web browser is connected to the Embedded Web Server of the PNP/1110. It shows you a static web page with some pictures.

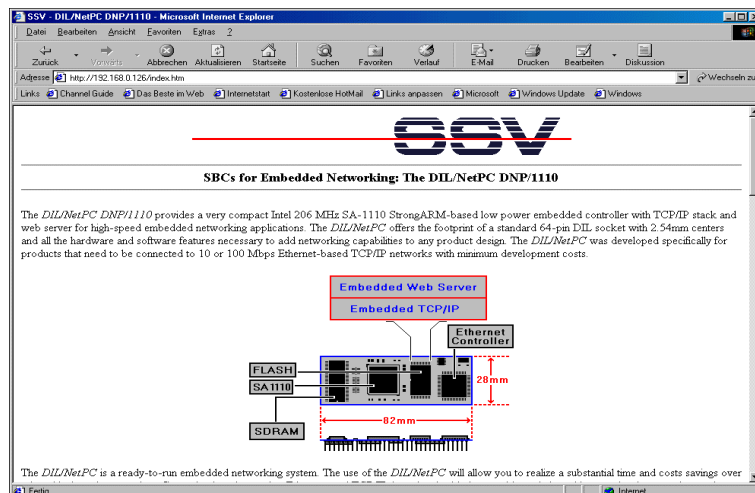

Figure 14: Web page shown by the MS-Internet Explorer

If your Web browser can't establish a connection to the Web Server – but the Ping was successful – you should check your browser settings. Please ensure, that your browser is joined with TCP/IP by using the Ethernet card in your development system. Alternatively you have to install a suitable Web browser.

In some cases the Web browser is only configured for modem based Internet access. In this case, please install a second Web browser from your original operating system CD-ROM.

5.1.4 Login via Serial Console

With a development system running under MS-Windows you can gain access onto the PNP/1110 via HyperTerminal by using the username *gast*. There is no specific password needed. On the point where the password is expected simply press the *Enter* (Return) key. Your system is now ready to execute arbitrary commands.

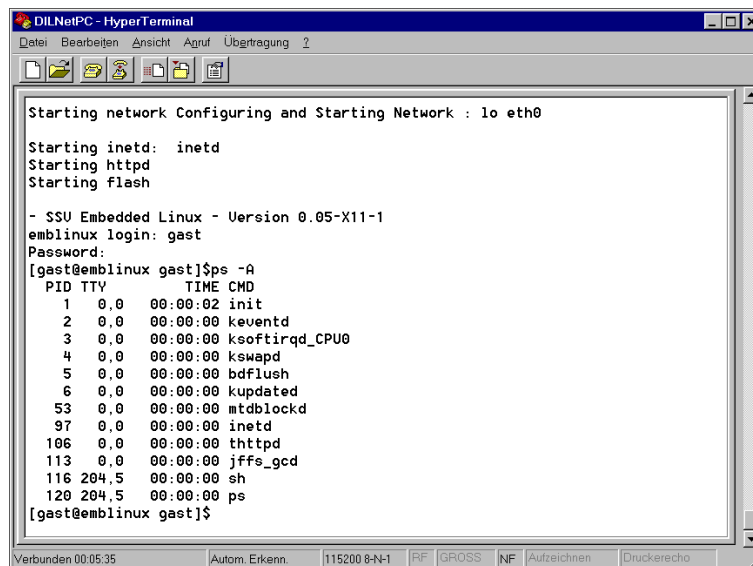

```
Starting network Configuring and Starting Network : lo eth0

Starting inetd: inetd
Starting httpd
Starting flash

- SSV Embedded Linux - Version 0.05-X11-1
emlinux login: gast
Password:
[gast@emlinux gast]$ps -A
  PID TTY          TIME CMD
    1  0,0   00:00:02 init
    2  0,0   00:00:00 keventd
    3  0,0   00:00:00 ksoftirqd_CPU0
    4  0,0   00:00:00 kswapd
    5  0,0   00:00:00 bdflush
    6  0,0   00:00:00 kupdated
   53  0,0   00:00:00 mtdblockd
   97  0,0   00:00:00 inetd
  106  0,0   00:00:00 thttpd
  113  0,0   00:00:00 jffs_gcd
  116 204,5   00:00:00 sh
  120 204,5   00:00:00 ps
[gast@emlinux gast]$
```

Figure 15: Login procedure via HyperTerminal

5.1.5 Login via Telnet

You are now able to start a Telnet client on the development system. Open a command shell and enter the following command:

```
telnet 192.168.0.126
```

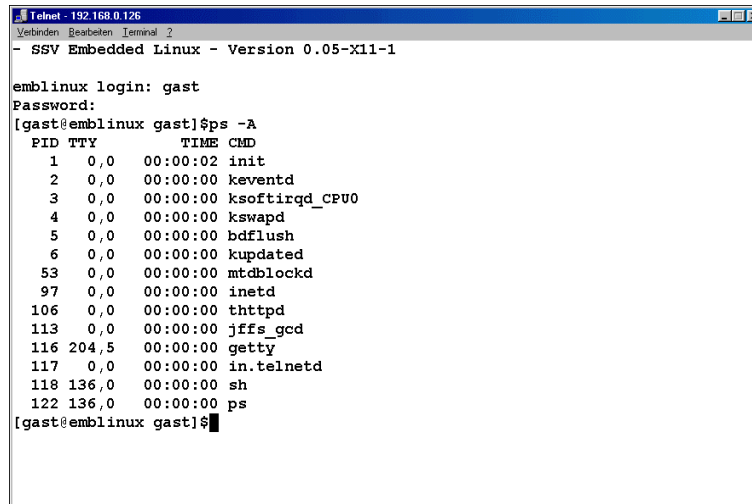

```
Telnet - 192.168.0.126
Verbinden Bearbeiten Interrupt 2
- SSV Embedded Linux - Version 0.05-X11-1

emlinux login: gast
Password:
[gast@emlinux gast]$ps -A
  PID TTY          TIME CMD
    1  0,0    00:00:02 init
    2  0,0    00:00:00 keventd
    3  0,0    00:00:00 ksoftirqd_CPU0
    4  0,0    00:00:00 kswapd
    5  0,0    00:00:00 bdflush
    6  0,0    00:00:00 kupdated
   53  0,0    00:00:00 mtdblockd
   97  0,0    00:00:00 inetd
  106  0,0    00:00:00 thttpd
  113  0,0    00:00:00 jffs_gcd
  116 204,5  00:00:00 getty
  117  0,0    00:00:00 in.telnetd
  118 136,0  00:00:00 sh
  122 136,0  00:00:00 ps
[gast@emlinux gast]$
```

Figure 16: Login procedure via Telnet

Please pay attention, that this command will pass the IP-address of your PNP/1110 as parameter to the client.

5.1.6 File Transfer via FTP

The **File Transfer Protocol (FTP)** provides a common approach to transfer files between clients and servers. FTP is a client/server protocol like Telnet. The FTP client/server capability is build into most Windows versions. An FTP session begins when the client builds a TCP/IP connection to the server. Once this connection is established, the client will log on to this server. In our actual case your development system acts as client and the PNP/1110 operates as server. After the successful access onto the server you are able to execute various file transfer commands, which typically concern the navigation through the FTP server's directory structure and send or receive files. In the following an example of an FTP session is shown.

To use the File Transfer Protocol on your system, please open a DOS window (via the Windows Start menu) and branch into the desired subdirectory. Now enter **FTP 192.168.0.126** and open an FTP connection between client and server. The system will now ask you for a username. To answer this request please enter **gast** and confirm the expected password with simply pressing the **Enter**-key. At this point there is no specific password required. On figure 16 you see the described user inputs in form of highlighted text.

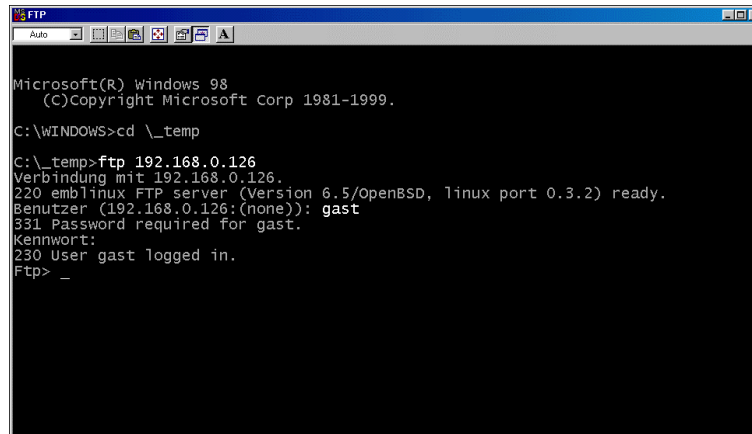

```

Microsoft(R) Windows 98
(C)Copyright Microsoft Corp 1981-1999.

C:\WINDOWS>cd \_temp

C:\_temp>Ftp 192.168.0.126
Verbindung mit 192.168.0.126.
220 emblinux FTP server (Version 6.5/OpenBSD, linux port 0.3.2) ready.
Benutzer (192.168.0.126:(none)): gast
331 Password required for gast.
Kennwort:
230 User gast logged in.
Ftp> _

```

Figure 17: Login procedure via FTP

Now you are ready to transfer a file from your Windows-based development system to the PNP/1110. Before you can transfer a file via FTP you should check, that the FTP link is set correctly to the binary operation mode via the **binary** command. In some cases the default setting is ASCII. With the **pwd** command you can check out the name of the remote directory. Please note, that the Read/Write access is only allowed for the directory **/home/gast**. To transfer a file from your development system to the PNP/1110 use the command:

put filename.

For a first view on the content of a directory you should use **ls -al**. This command shows you the files stored inside a specific directory. To terminate an FTP session use the command **bye**. This will cancel every operation between client and server. Figure 18 shows you these operations.

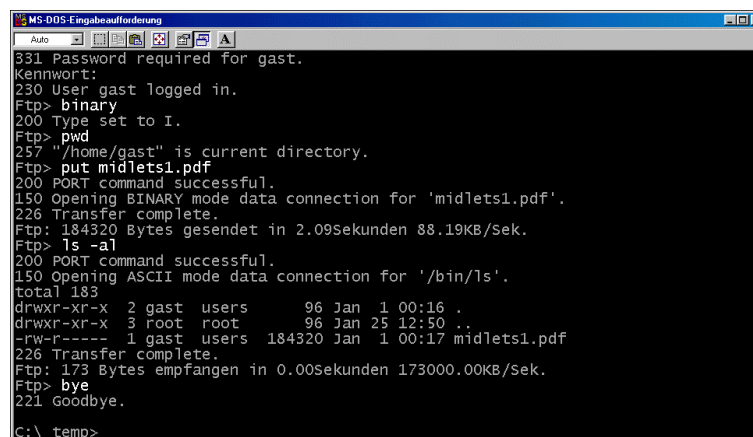

```

MS-DOS: Eingabeaufforderung

331 Password required for gast.
Kennwort:
230 User gast logged in.
Ftp> binary
200 Type set to I.
Ftp> pwd
257 "/home/gast" is current directory.
Ftp> put midlets1.pdf
200 PORT command successful.
150 Opening BINARY mode data connection for 'midlets1.pdf'.
226 Transfer complete.
Ftp: 184320 Bytes gesendet in 2.09Sekunden 88.19KB/Sek.
Ftp> ls -al
200 PORT command successful.
150 Opening ASCII mode data connection for '/bin/ls'.
total 183
drwxr-xr-x  2 gast  users      96 Jan  1 00:16 .
drwxr-xr-x  3 root  root       96 Jan 25 12:50 ..
-rw-r----- 1 gast  users 184320 Jan  1 00:17 midlets1.pdf
226 Transfer complete.
Ftp: 173 Bytes empfangen in 0.00Sekunden 173000.00KB/Sek.
Ftp> bye
221 Goodbye.

C:\_temp>

```

Figure 18: FTP file transfer under DOS

In some Windows versions the Internet Explorer is able to act as FTP client just like an Internet browser. To transfer files by using the Internet Explorer enter *ftp://gast@192.168.0.126* as URL into the address bar. Moreover open the Windows Explorer as second file destination. Now you can transfer your desired files very easy by using drag and drop between these two windows. Simply drag the selected file(s) from the Windows Explorer into the Internet Explorer window and drop it down into the chosen directory.

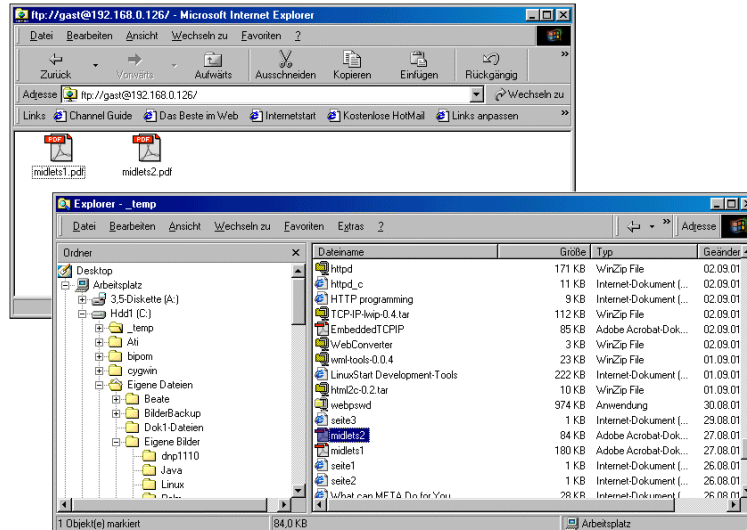

Figure 19: File transfer with the Internet Explorer

5.1.7 Embedded Linux Maintenance

The Embedded Linux of the PNP/1110 consists of two basic parts. At first the file *zimage* as Linux-kernel and second the root filesystem in form of the file *rimage.gz*. Each component exists as a separate file. You can find the file *rimage.gz* on the DIL/NetPC Starterkit CD-ROM under the location *\Linux\PNP1110-Flash\2.4.18\Rel1\rimage.gz*. The file *zimage* is placed in the directory *\Linux\PNP1110-Flash\2.4.18\Rel1\zimage*.

For updates or the newest versions of these files please check out our website at: <http://www.dilnetpc.com>

5.1.8 Embedded Linux Maintenance via HyperTerminal/Serial Link

The PNP/1110 offers the capability to upload a Linux binary image, to save it into the Flash memory and to reboot the system after a successful receive. Please open a HyperTerminal window and reboot the PNP/1110. Now you have to start up the Flash Loader. For this you have to press **CTRL+L** during the boot procedure. Figure 20 shows the BIOS report sequence.

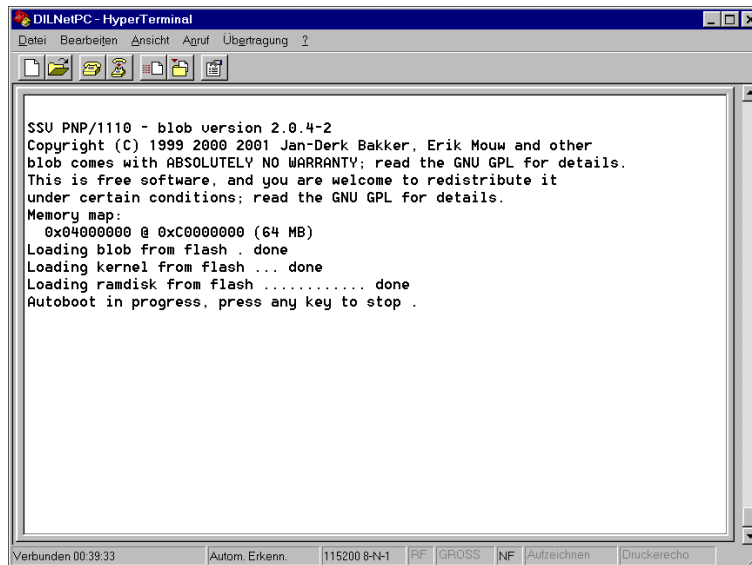

```
DILNetPC - HyperTerminal
Datei Bearbeiten Ansicht Agruf Übertragung ?
[Icons]
SSU PNP/1110 - blob version 2.0.4-2
Copyright (C) 1999 2000 2001 Jan-Derk Bakker, Erik Mouw and other
blob comes with ABSOLUTELY NO WARRANTY; read the GNU GPL for details.
This is free software, and you are welcome to redistribute it
under certain conditions; read the GNU GPL for details.
Memory map:
 0x04000000 @ 0xC0000000 (64 MB)
Loading blob from flash . done
Loading kernel from flash ... done
Loading ramdisk from flash ..... done
Autoboot in progress, press any key to stop .
Verbunden 00:39:33 Autom. Erkenn. 115200 8-N-1 RF GROSS NF Aufzeichnen Druckerecho
```

Figure 20: Boot Procedure

Once the BIOS detect the CTRL+L the Flash Loader starts and offers three options (see Figure 21). Please choose option "1" to transfer data via "YMODEM PROTOCOL". Once you have pressed the key "1" the Flash Loader is set in a wait state until a file for transferring is selected in the appearing window. During this status the Flash Loader is continuously sending the letter "C" to the console as you can see in Figure 21. With this sign the YMODEM synchronizes the beginning of a file transmission.

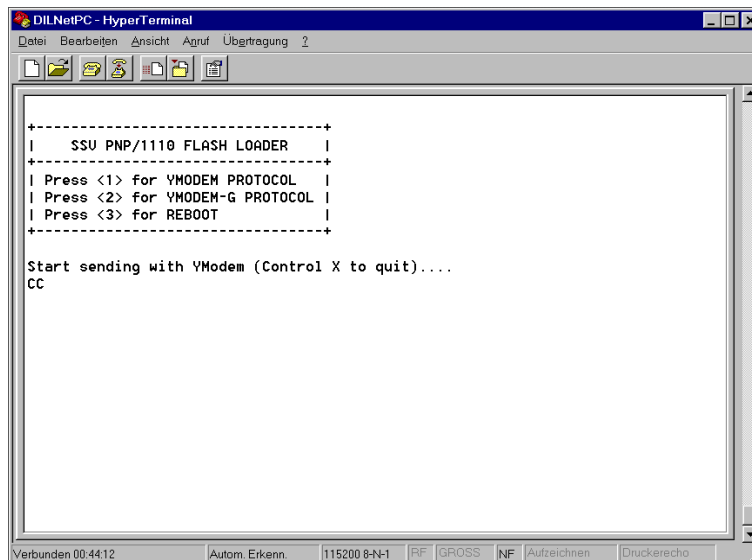

```
DILNetPC - HyperTerminal
Datei Bearbeiten Ansicht Agruf Übertragung ?
[Icons]
+-----+
|  SSU PNP/1110 FLASH LOADER  |
+-----+
| Press <1> for YMODEM PROTOCOL |
| Press <2> for YMODEM-G PROTOCOL |
| Press <3> for REBOOT         |
+-----+
Start sending with YModem (Control X to quit)....
CC
Verbunden 00:44:12 Autom. Erkenn. 115200 8-N-1 RF GROSS NF Aufzeichnen Druckerecho
```

Figure 21: Flash Loader Messages

Now select the desired file (*rimage.gz* or *zimage*) in the appearing window and start the transmission with YMODEM.

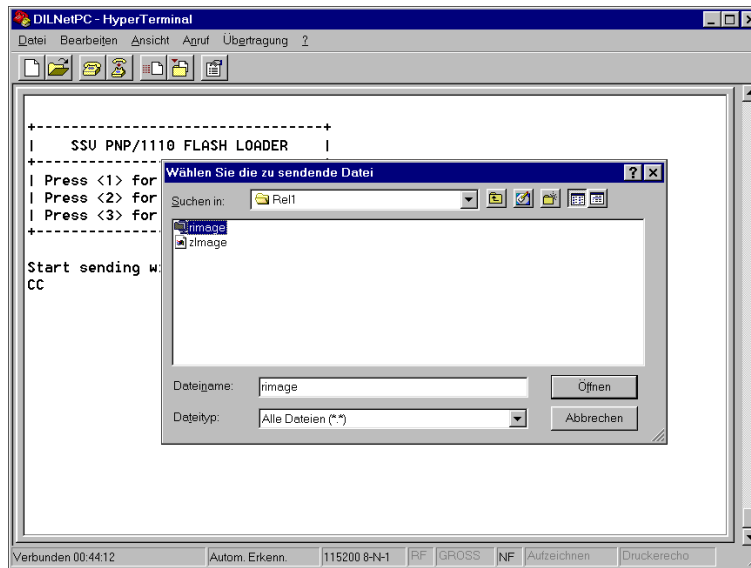

Figure 22: Flash Loader file Select

During the download you will see a progress bar that indicates the state of transmission. Please wait absolutely until the file transmission ends and avoid interruptions. In case of interruption or failure the PNP/1110 would not contain any bootable system and you have to repeat the transmission procedure. After the end of transmission the Flash Loader returns into the menu and continues sending the "C" sign. To reboot the PNP/1110 with the new kernel and/or root filesystem choose option "3" (REBOOT) from the Flash Loader menu.

5.2 Using a Linux–based development System

The following paragraphs will help you to use the PNP/1110 with a development system running under Linux. For this steps are some programs necessary, which normally come along with the Linux installation (i.e. Minicom). Please make sure that these programs are present on your development system. If necessary you have to install these programs from your Linux installation CD.

5.2.1 Setup the Serial Link

Before you provide the Evaluation Board with power for the first time, please run a terminal program like **Minicom**. Minicom is a simple serial communication program originally written by Miquel van Smoorenburg. It offers basic communication capabilities and integrates well with the Linux user interface. Minicom is a lot like the old MS-DOS program PROCOMM. This program can be used to connect a Linux-based PC to embedded devices such as the PNP/1110 for initial configurations. In the following we will show you how to use Minicom and what you have to do to adjust the necessary settings.

Open a terminal window and type in the command *minicom -s* to get access to the serial port settings. Now you can change some configuration parameters – such as the maximum baud rate. Set the serial port parameters for the maximum baud rate on "115.200 bps".

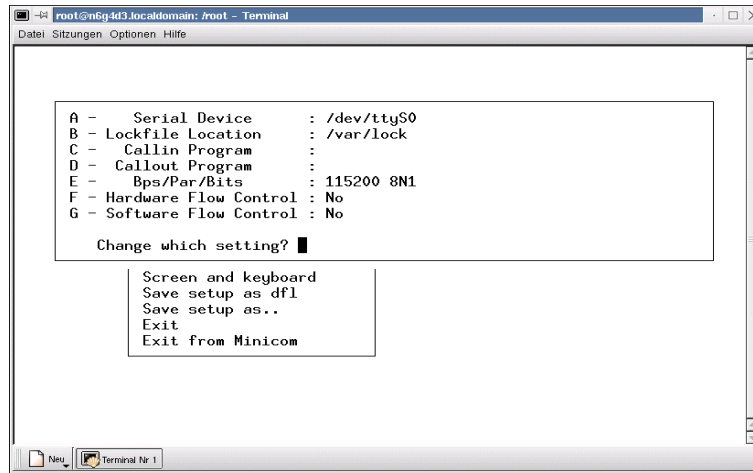

Figure 23: Serial Port Settings under Minicom

After that, please turn on the power for the Evaluation Board. You will now see all steps of the PNP/1110 boot process via Minicom.

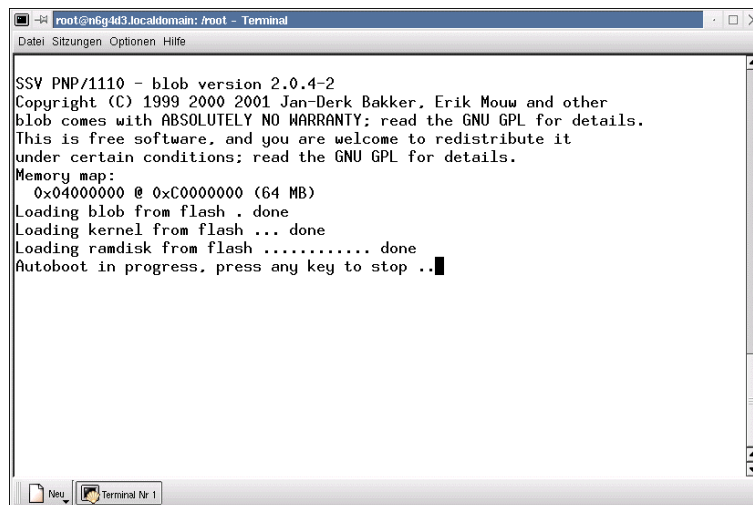
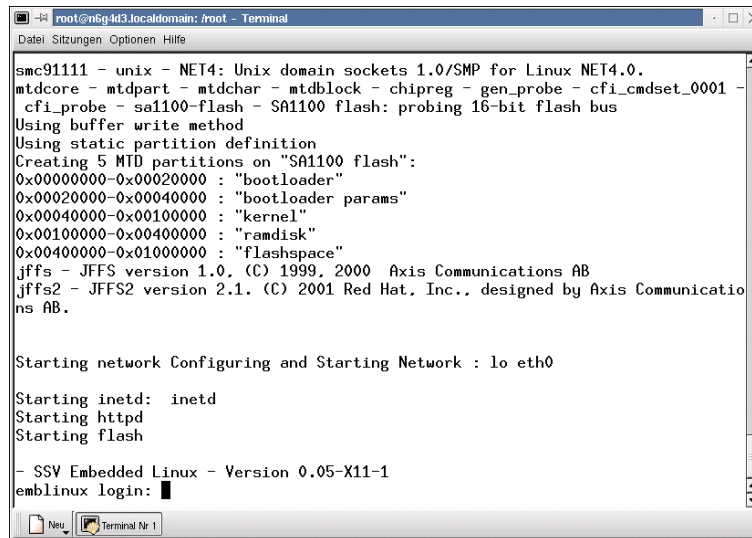

Figure 24: Boot Procedure

To the end of this sequence a login request will appear. The boot process of the PNP/1110 is now complete.



```

root@n6g4d3.localdomain: /root - Terminal
Datei Sitzungen Optionen Hilfe

smc91111 - unix - NET4: Unix domain sockets 1.0/SMP for Linux NET4.0.
mtdcore - mtdpart - mtdchar - mtdblock - chipreg - gen_probe - cfi_cmdset_0001 -
cfi_probe - sa1100-flash - SA1100 flash: probing 16-bit flash bus
Using buffer write method
Using static partition definition
Creating 5 MTD partitions on "SA1100 flash":
0x00000000-0x00020000 : "bootloader"
0x00020000-0x00040000 : "bootloader params"
0x00040000-0x00100000 : "kernel"
0x00100000-0x00400000 : "ramdisk"
0x00400000-0x01000000 : "flashspace"
jffs - JFFS version 1.0. (C) 1999, 2000 Axis Communications AB
jffs2 - JFFS2 version 2.1. (C) 2001 Red Hat, Inc., designed by Axis Communicatio
ns AB.

Starting network Configuring and Starting Network : lo eth0

Starting inetd: inetd
Starting httpd
Starting flash

- SSV Embedded Linux - Version 0.05-X11-1
emlinux login: █

```

Figure 25: Login Request

5.2.2 Checking the Ethernet Link

Please open a terminal window and type in *ping 192.168.0.126*. Every ping request has to be answered by your PNP/1110 similar as shown in figure 26.

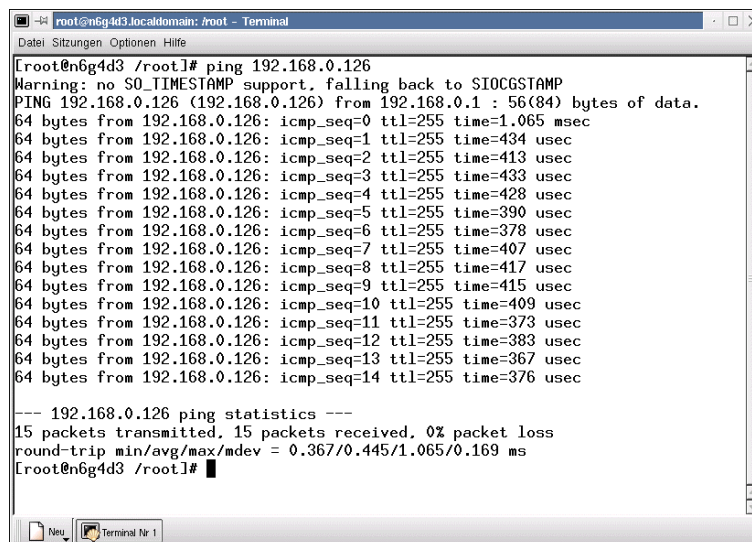

```

root@n6g4d3.localdomain: /root - Terminal
Datei Sitzungen Optionen Hilfe

[root@n6g4d3 /root]# ping 192.168.0.126
Warning: no SO_TIMESTAMP support, falling back to SIOCGSTAMP
PING 192.168.0.126 (192.168.0.126) from 192.168.0.1 : 56(84) bytes of data.
64 bytes from 192.168.0.126: icmp_seq=0 ttl=255 time=1.065 msec
64 bytes from 192.168.0.126: icmp_seq=1 ttl=255 time=434 usec
64 bytes from 192.168.0.126: icmp_seq=2 ttl=255 time=413 usec
64 bytes from 192.168.0.126: icmp_seq=3 ttl=255 time=433 usec
64 bytes from 192.168.0.126: icmp_seq=4 ttl=255 time=428 usec
64 bytes from 192.168.0.126: icmp_seq=5 ttl=255 time=390 usec
64 bytes from 192.168.0.126: icmp_seq=6 ttl=255 time=378 usec
64 bytes from 192.168.0.126: icmp_seq=7 ttl=255 time=407 usec
64 bytes from 192.168.0.126: icmp_seq=8 ttl=255 time=417 usec
64 bytes from 192.168.0.126: icmp_seq=9 ttl=255 time=415 usec
64 bytes from 192.168.0.126: icmp_seq=10 ttl=255 time=409 usec
64 bytes from 192.168.0.126: icmp_seq=11 ttl=255 time=373 usec
64 bytes from 192.168.0.126: icmp_seq=12 ttl=255 time=383 usec
64 bytes from 192.168.0.126: icmp_seq=13 ttl=255 time=367 usec
64 bytes from 192.168.0.126: icmp_seq=14 ttl=255 time=376 usec

--- 192.168.0.126 ping statistics ---
15 packets transmitted, 15 packets received, 0% packet loss
round-trip min/avg/max/mdev = 0.367/0.445/1.065/0.169 ms
[root@n6g4d3 /root]# █

```

Figure 26: Ping Request

To cancel the ping request just press the keyboard shortcut *Ctrl+C*. If an error occurs (e.g. the PNP/1110 don't answer the ping of your development system) you have to check your cable connections at first.

Then you should check if the IP-address is set correctly to "192.168.0.1". For an easy check of the IP-address, you can use the Linux-command *ifconfig*.

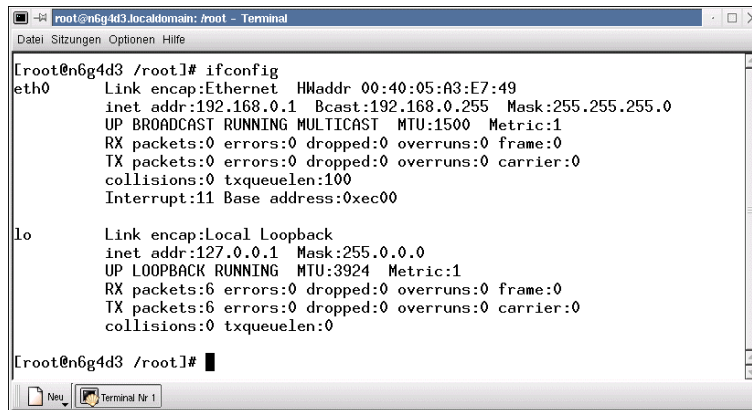

Figure 27: IP-address check via ifconfig

5.2.3 Web Server Access

Once the ping was successful, you are ready to start a Web browser on your development system. This may be the Konqueror File Manager or the Netscape Communicator/Navigator. The Konqueror File Manager is normally part of the Linux installation and acts as File Manager as well as Web browser. Konqueror is able to detect automatically when an URL were entered and shows the content.

Just enter the URL *http://192.168.0.126/index.htm* and press the *Enter*-key. The Embedded Web Server will deliver you a small description about the PNP/1110.

That's it. You are now online with the Starter Kit. The Web browser of your development system is connected to the Embedded Web Server of the PNP/1110 and shows you a static web page with some pictures. Figure 28 will show this.

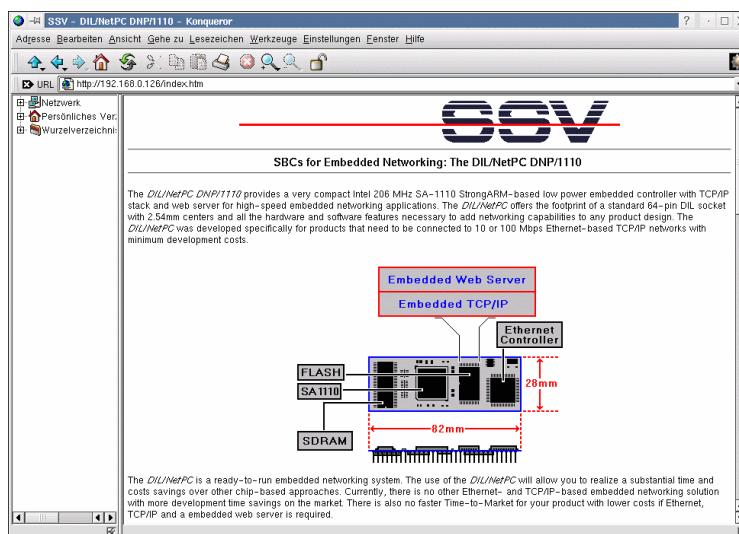
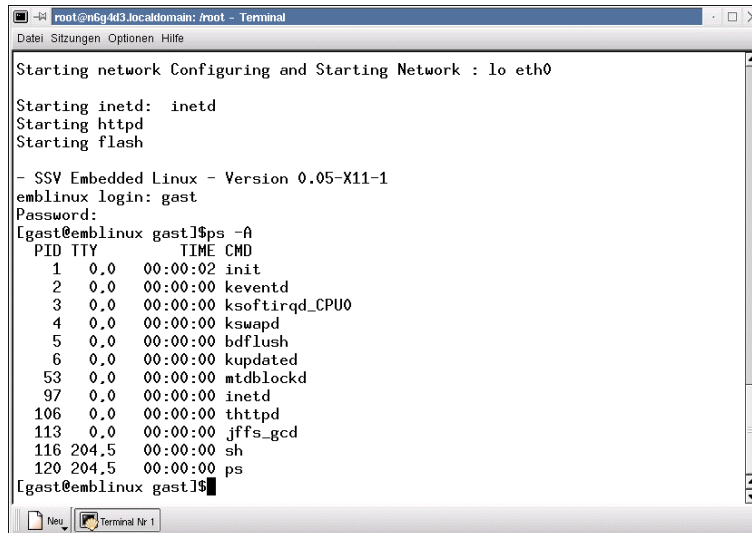

Figure 28: Web page shown by the Konqueror File Manager

5.2.4 Login via Serial Console

Under Linux you can gain access onto the PNP/1110 via Minicom by using the username *gast*. A specific password is not necessary. At this point simply press the *Enter* (Return) key. Your system is now ready to execute arbitrary Linux commands.



```

root@n6g4d3.localdomain: /root - Terminal
Datei Sitzungen Optionen Hilfe

Starting network Configuring and Starting Network : lo eth0

Starting inetd: inetd
Starting httpd
Starting flash

- SSV Embedded Linux - Version 0.05-X11-1
emblinux login: gast
Password:
lgast@emblinux gast]$ps -A
  PID TTY          TIME CMD
    1  0.0   00:00:02 init
    2  0.0   00:00:00 keventd
    3  0.0   00:00:00 ksoftirqd_CPU0
    4  0.0   00:00:00 kswapd
    5  0.0   00:00:00 bdflush
    6  0.0   00:00:00 kupdated
   53  0.0   00:00:00 mtdblockd
   97  0.0   00:00:00 inetd
  106  0.0   00:00:00 thttpd
  113  0.0   00:00:00 jffs_gcd
  116 204.5   00:00:00 sh
  120 204.5   00:00:00 ps
lgast@emblinux gast]$

```

Figure 29: Login procedure via Minicom

5.2.5 Login via Telnet

You are now able to start a telnet client on the development system. Open a Minicom command shell and enter the following command:

telnet 192.168.0.126

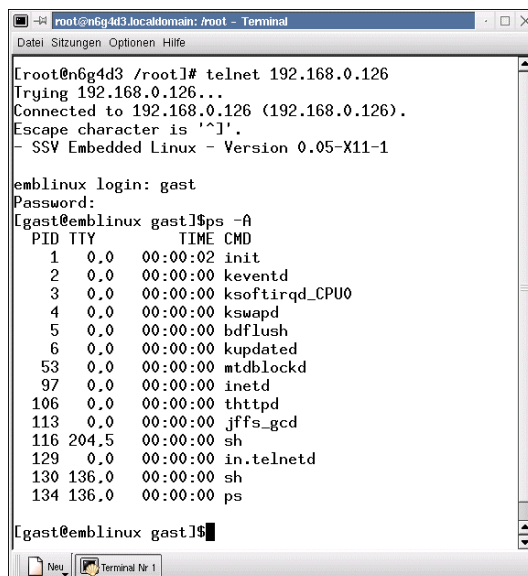

```

root@n6g4d3.localdomain: /root - Terminal
Datei Sitzungen Optionen Hilfe

[root@n6g4d3 /root]# telnet 192.168.0.126
Trying 192.168.0.126...
Connected to 192.168.0.126 (192.168.0.126).
Escape character is '^J'.
- SSV Embedded Linux - Version 0.05-X11-1

emblinux login: gast
Password:
lgast@emblinux gast]$ps -A
  PID TTY          TIME CMD
    1  0.0   00:00:02 init
    2  0.0   00:00:00 keventd
    3  0.0   00:00:00 ksoftirqd_CPU0
    4  0.0   00:00:00 kswapd
    5  0.0   00:00:00 bdflush
    6  0.0   00:00:00 kupdated
   53  0.0   00:00:00 mtdblockd
   97  0.0   00:00:00 inetd
  106  0.0   00:00:00 thttpd
  113  0.0   00:00:00 jffs_gcd
  116 204.5   00:00:00 sh
  129  0.0   00:00:00 in.telnetd
  130 136.0   00:00:00 sh
  134 136.0   00:00:00 ps
lgast@emblinux gast]$

```

Figure 30: Login procedure via Telnet

Please pay attention, that this command will pass the IP-address of your PNP/1110 as parameter to the client.

5.2.6 File Transfer via FTP

The **File Transfer Protocol** (FTP) provides a common approach to transfer files between clients and servers. FTP is a client/server protocol like Telnet. An FTP session begins when the client builds a TCP/IP connection to the server. Once this connection is established, the client will log on to this server. In our actual case your development system acts as client and the PNP/1110 operates as server. After the successful access onto the server you are able to execute various file transfer commands, which typically involves navigating the FTP server's directory structure and send or receive files. In the following an example of an FTP Session is shown. The FTP client/server capability is already build into the Konqueror.

To use the File Transfer Protocol on your Linux system please open a command shell, like Minicom and branch into the desired subdirectory. Now enter **FTP 192.168.0.126** and open an FTP connection between client and server. The system will now ask you for a username. To answer this request please enter **gast** and confirm the expected password with pressing **Enter**. At this point there is no specific password required. On figure 31 you see the user inputs as highlighted text.

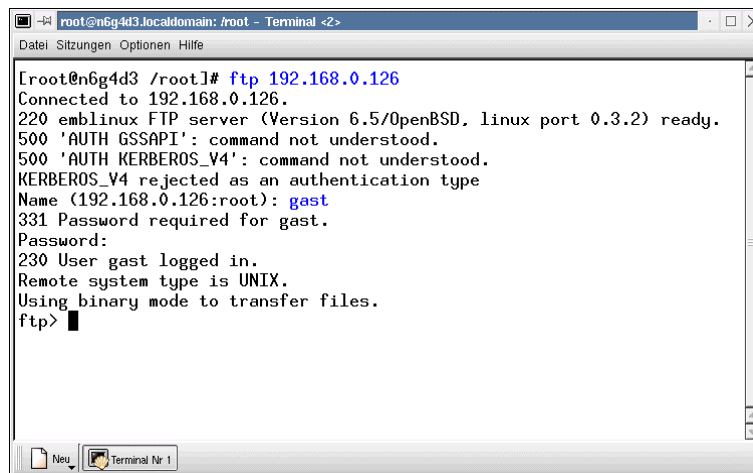

```
[root@n6g4d3 /root]# ftp 192.168.0.126
Connected to 192.168.0.126.
220 emlinux FTP server (Version 6.5/OpenBSD, linux port 0.3.2) ready.
500 'AUTH GSSAPI': command not understood.
500 'AUTH KERBEROS_V4': command not understood.
KERBEROS_V4 rejected as an authentication type
Name (192.168.0.126:root): gast
331 Password required for gast.
Password:
230 User gast logged in.
Remote system type is UNIX.
Using binary mode to transfer files.
ftp>
```

Figure 31: Login procedure via FTP

Now you are ready to transfer a file from a Linux-based development system to the PNP/1110. Before you can transfer a file with FTP you should check, that the FTP link mode is correctly set to the binary operation mode via the **binary** command. In some cases the default setting is ASCII. With the command **pwd** you can check out the name of the remote directory. The Read/Write access is only allowed for the directory **/home/gast**. To transfer a file from your development system to the PNP/1110 use **put filename** to transfer the desired file.

For a first view on the content of a directory you should use **ls -al**. This command shows you the files stored inside a specific directory. To terminate an FTP session use the command **bye**.

This command cancels every operation between server and client. Figure 32 shows you these operations.

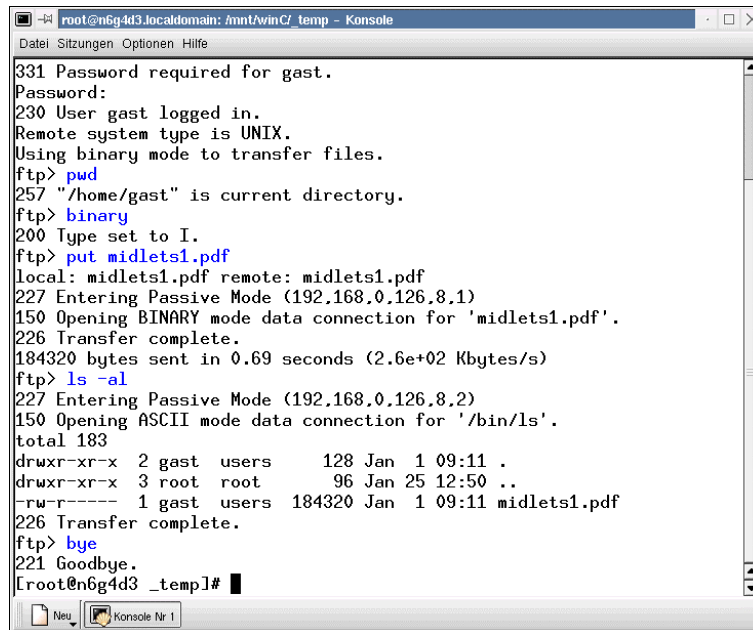

Figure 32: File transfer with Minicom

Next to Minicom it is also possible to use the Konqueror File Manager to transfer files by FTP. For this, please open Konqueror and enter *ftp://gast@192.168.0.126* as URL into the address bar. The Konqueror knows the difference between your system directories and folders (\\) and an Internet or intranet address (/). So you can simply type in the desired address. Open a second instance of Konqueror and change into the desired source directory. After that, you are able to transfer arbitrary files very easy by using drag and drop between these two Konqueror windows.

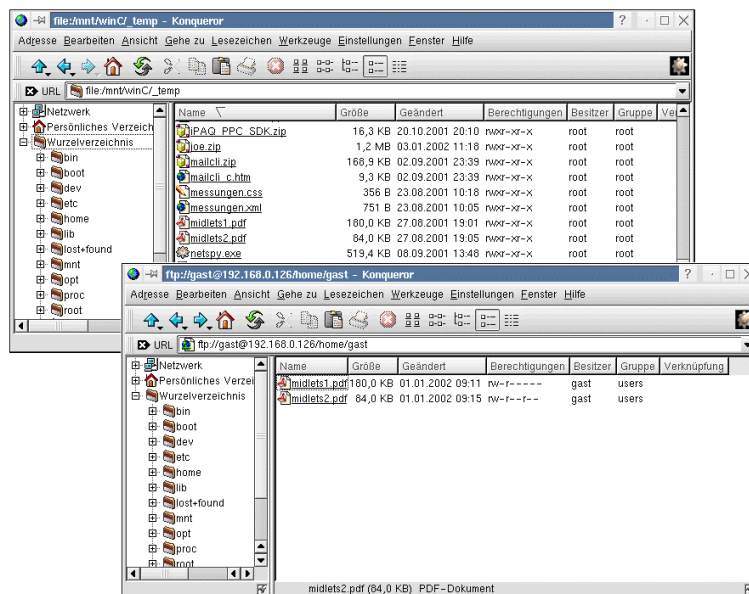

Figure 33: File transfer with the Konqueror

5.2.7 Embedded Linux Maintenance

The Embedded Linux of the PNP/1110 consists of two basic parts. At first the file *zimage* as Linux-kernel and second the root filesystem in form of the file *rimage.gz*. Each of the both components exists as one separate file. You can find the file *rimage.gz* on the DIL/NetPC Starterkit CD-ROM under the location `\Linux\PNP1110-Flash\2.4.18\Rel1\rimage.gz`. The file *zimage* is placed in the directory `\Linux\PNP1110-Flash\2.4.18\Rel1\zimage`.

For updates or the newest versions of these files please check out our website at: <http://www.dilnetpc.com>

5.2.8 Embedded Linux Maintenance via Minicom/Serial Link

The PNP/1110 offers the capability to upload a Linux binary image, to save it into the Flash memory and to reboot the system after a successful receive. Please open a Minicom window and reboot the PNP/1110. Now you have to invoke the Flash Loader. For this press **CTRL+L** during the boot procedure. Figure 34 shows the BIOS report sequence.

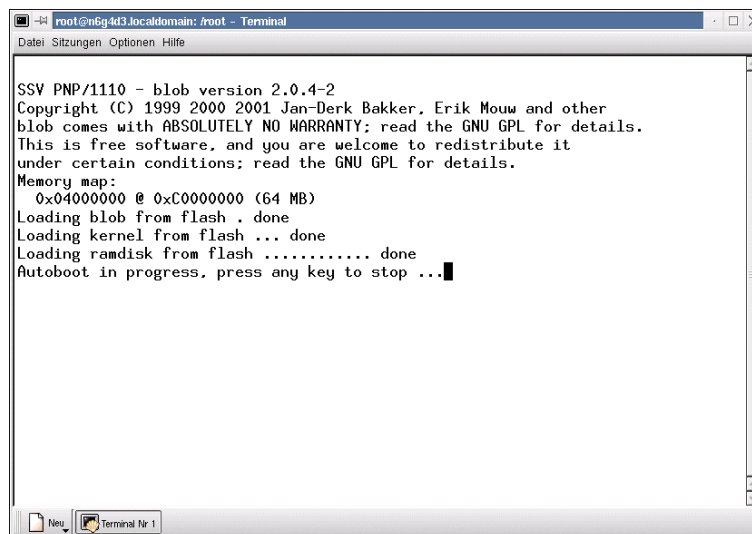

```
root@nbg443.localdomain: /root - Terminal
Datei Sitzungen Optionen Hilfe

SSV PNP/1110 - blob version 2.0.4-2
Copyright (C) 1999 2000 2001 Jan-Derk Bakker, Erik Mouw and other
blob comes with ABSOLUTELY NO WARRANTY; read the GNU GPL for details.
This is free software, and you are welcome to redistribute it
under certain conditions; read the GNU GPL for details.
Memory map:
 0x04000000 @ 0xC0000000 (64 MB)
Loading blob from flash . done
Loading kernel from flash ... done
Loading ramdisk from flash ..... done
Autoboot in progress, press any key to stop ...
```

Figure 34: Boot Procedure

Once the BIOS detect the CTRL+L the Flash Loader invokes and offers three options (see figure 35).

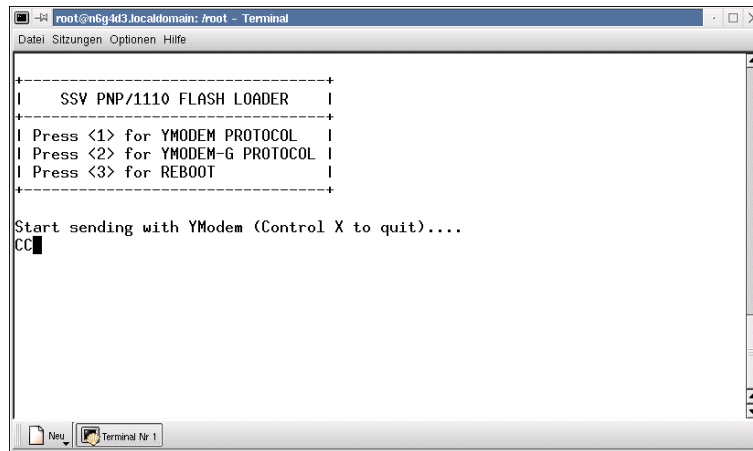

Figure 35: Flash Loader Messages

Please choose option "1" to transfer data via "YMODEM PROTOCOL". Once you have pressed the key "1" the Flash Loader is set in a wait state. During this status the Flash Loader is continuously sending the letter "C" to the console as you can see in figure 35. With this sign the YMODEM synchronize the beginning of a file transmission.

Open the Minicom upload menu with the key combination **ALT+S**. Now you see five options to transmit data. On this point you have absolutely to choose the option "zmodem".

The reason to do this although you normally would choose ymodem is a little bug in Minicom, so here you have to select zmodem absolutely. Choosing "ymodem" may result in different error messages.

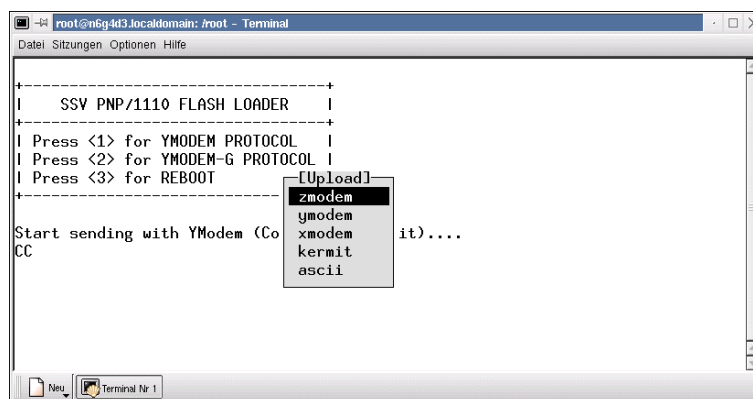

Figure 36: Transfer method Select

After you have chosen the transmission method Minicom opens a new window. Now select the desired file (*rimage.gz* or *zimage*) and start the transmission.

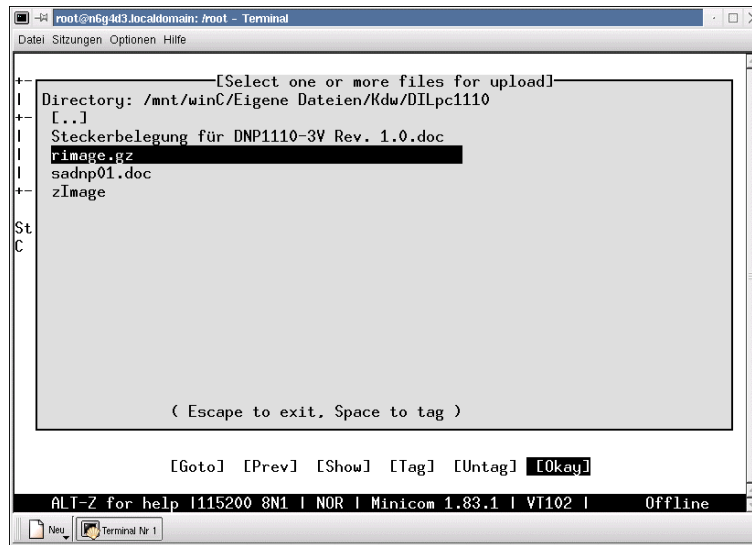

Figure 37: Transmission file Select

During the download you will see a progress bar that indicates the transmission status. Please wait absolutely until the file transmission ends and avoid every interruption. In case of an interruption or failure the PNP/1110 would not contain any bootable system and you have to repeat the transmission procedure.

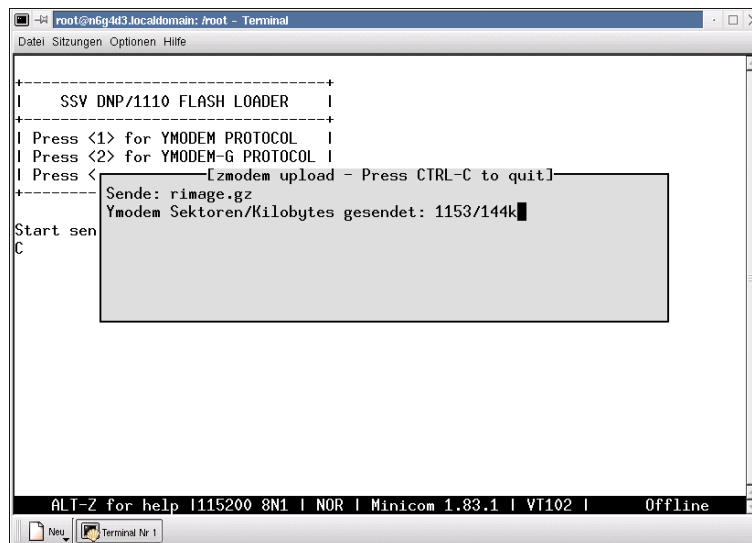

Figure 38: Transmission Status

After a successful transmission the FLASH Loader returns into the menu and continues with sending the letter "C". To reboot the PNP/1110 with the new kernel and/or root filesystem choose option "3" (REBOOT) from the Flash Loader menu. After this, the PNP/1110 restarts with the new kernel and/or root filesystem.

5.2.9 Installation of the GNU Cross Toolchain

Within the scope of supply of the PNP/1110 Starter Kit we deliver a full pre-build GNU cross toolchain as development environment. With this cross development environment you are able to create the necessary code for the PNP/1110 with StrongARM architecture although you work on an x86 Linux-based development system. The complete cross development environment exists in form of a single tar-archive on the Starter Kit CD-ROM. On figure 39 you can see the location of this tar-archive in the directory:

/Linux/PNP1110-ToolChain

This compressed archive has a size of approximately 85 MByte.

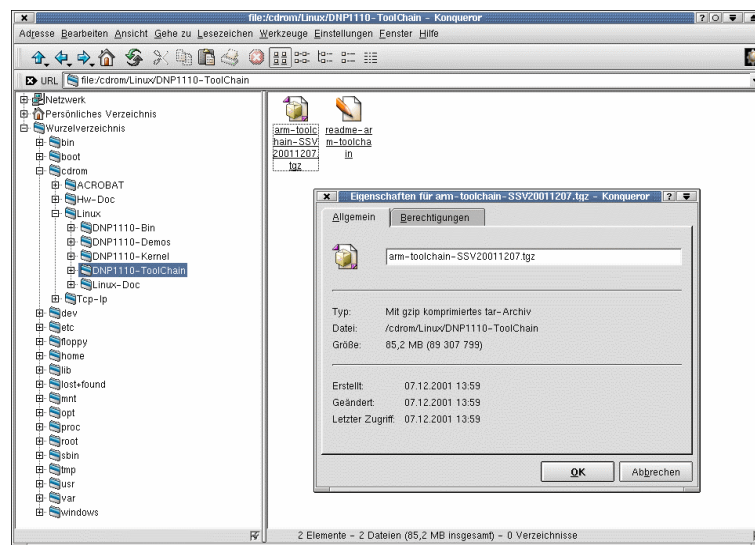

Figure 39: Location of the tar-archive on the Starter Kit CD-ROM

To install the toolchain archive on your Linux-based development system you have to be logged-in as Administrator with the respective rights. After this, you just have to unpack the entire tar-archive outgoing from the directory

/usr/local

To unpack these archive please execute the following Linux command line from a terminal window. You can see this also on figure 40:

```
tar -xzf /cdrom/Linux/PNP1110-ToolChain/arm-toolchain-SSV20020812.tgz
```

Instead of `.../cdrom/...` please use the correct path to your own CD-ROM drive. The Linux tar program needs some time to unpack all files from the CD-ROM to your hard disk.

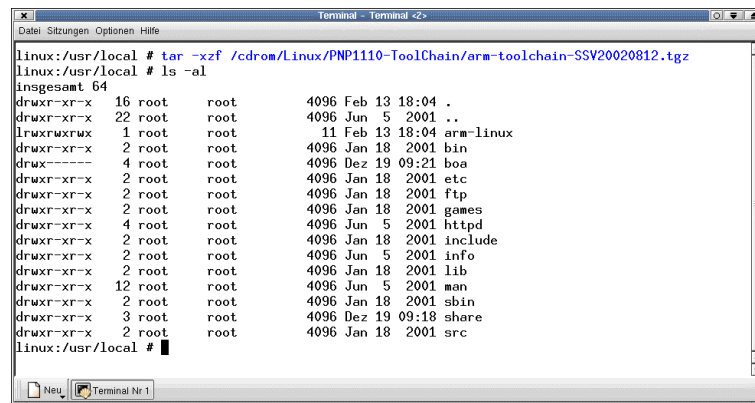

```

Terminal - Terminal <2>
Datei Sitzungen Optionen Hilfe
linux:/usr/local # tar -xzf /cdrom/Linux/PNP1110-ToolChain/arm-toolchain-SSV20020812.tgz
linux:/usr/local # ls -al
insgesamt 64
drwxr-xr-x 16 root root 4096 Feb 13 18:04 .
drwxr-xr-x 22 root root 4096 Jun 5 2001 ..
lrwxrwxrwx 1 root root 11 Feb 13 18:04 arm-linux
drwxr-xr-x 2 root root 4096 Jan 18 2001 bin
drwxr-xr-x 4 root root 4096 Dez 19 09:21 boa
drwxr-xr-x 2 root root 4096 Jan 18 2001 etc
drwxr-xr-x 2 root root 4096 Jan 18 2001 ftp
drwxr-xr-x 2 root root 4096 Jan 18 2001 games
drwxr-xr-x 4 root root 4096 Jun 5 2001 httpd
drwxr-xr-x 2 root root 4096 Jan 18 2001 include
drwxr-xr-x 2 root root 4096 Jun 5 2001 info
drwxr-xr-x 2 root root 4096 Jan 18 2001 lib
drwxr-xr-x 12 root root 4096 Jun 5 2001 man
drwxr-xr-x 2 root root 4096 Jan 18 2001 sbin
drwxr-xr-x 3 root root 4096 Dez 19 09:18 share
drwxr-xr-x 2 root root 4096 Jan 18 2001 src
linux:/usr/local #

```

Figure 40: Unpacking the tar-Archive

For a first test of your new cross development environment you should save a simple C source code – like the *Hallo Welt* program shown in figure 41 – into a file within the directory `/usr/local`. Under Linux you can do this directly via the command:

```
cat > filename
```

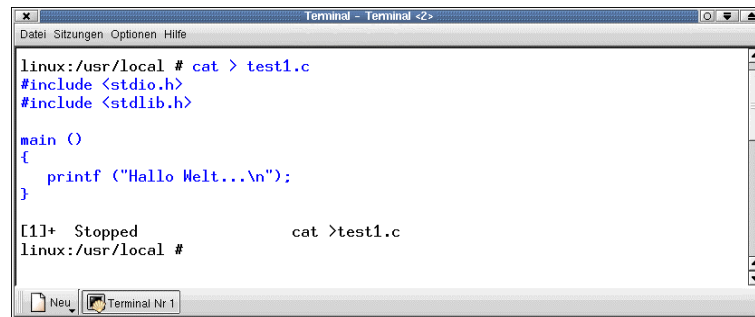

```

Terminal - Terminal <2>
Datei Sitzungen Optionen Hilfe
linux:/usr/local # cat > test1.c
#include <stdio.h>
#include <stdlib.h>

main ()
{
    printf ("Hallo Welt...\n");
}

[[1]+ Stopped cat >test1.c
linux:/usr/local #

```

Figure 41: A simple C-Program

To complete the C source code input, please press the key combination **CTRL+D**. If desired it is possible to check the file content by entering the command line:

```
cat test1.c
```

At next the GNU C cross compiler have to translate this C source code for the first time. During this translation process no error messages may occur. To build an executable binary file *test1* from *test1.c* use the following Linux command line from a terminal window:

```
/usr/local/arm/2.95.2/bin/arm-linux-gcc -o test1 test1.c
```

Figure 42 shows this command line.

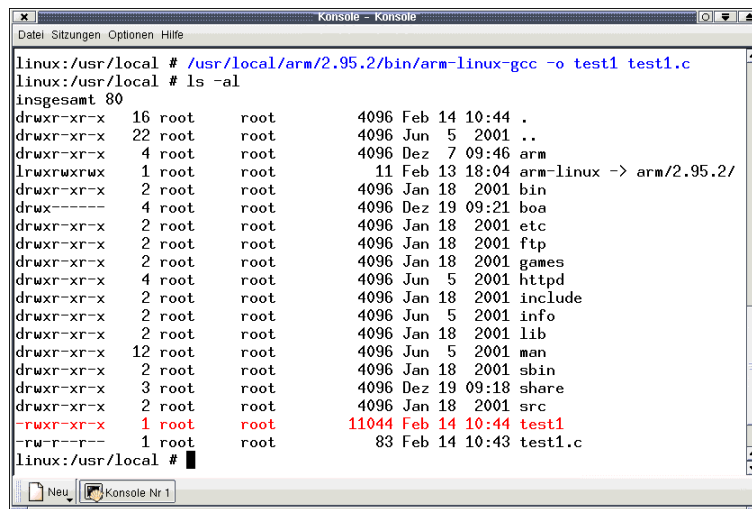

```

Konsole - Konsole
Datei Sitzungen Optionen Hilfe
linux:/usr/local # /usr/local/arm/2.95.2/bin/arm-linux-gcc -o test1 test1.c
linux:/usr/local # ls -al
insgesamt 80
drwxr-xr-x 16 root root 4096 Feb 14 10:44 .
drwxr-xr-x 22 root root 4096 Jun 5 2001 ..
drwxr-xr-x 4 root root 4096 Dez 7 09:46 arm
lrwxrwxrwx 1 root root 11 Feb 13 18:04 arm-linux -> arm/2.95.2/
drwxr-xr-x 2 root root 4096 Jan 18 2001 bin
dwx----- 4 root root 4096 Dez 19 09:21 boa
drwxr-xr-x 2 root root 4096 Jan 18 2001 etc
drwxr-xr-x 2 root root 4096 Jan 18 2001 ftp
drwxr-xr-x 2 root root 4096 Jan 18 2001 games
drwxr-xr-x 4 root root 4096 Jun 5 2001 httpd
drwxr-xr-x 2 root root 4096 Jan 18 2001 include
drwxr-xr-x 2 root root 4096 Jun 5 2001 info
drwxr-xr-x 2 root root 4096 Jan 18 2001 lib
drwxr-xr-x 12 root root 4096 Jun 5 2001 man
drwxr-xr-x 2 root root 4096 Jan 18 2001 sbin
drwxr-xr-x 3 root root 4096 Dez 19 09:18 share
drwxr-xr-x 2 root root 4096 Jan 18 2001 src
-rwxr-xr-x 1 root root 11044 Feb 14 10:44 test1
-rw-r--r-- 1 root root 83 Feb 14 10:43 test1.c
linux:/usr/local #

```

Figure 42: C-source code Compiling

After this, transfer the executable binary file from your development system to the PNP/1110 RAM disk within an FTP session. For this, enter the following command line within a terminal window and open an FTP connection between client and server:

```
ftp 192.168.0.126
```

The system asks now for a username. To answer this request please enter *gast* and confirm the expected password with pressing *Enter*. At this point of time there is no specific password required.

To transfer the binary file *test1* from your development system to the PNP/1110 use the command:

```
put test1
```

After the successful transfer you can terminate the FTP session with the command:

```
bye
```

This command will cancel every operation between client and server. On figure 42 you see the required user inputs as highlighted text.

At least run the new binary file on your PNP/1110. Open a Telnet session and start the program.

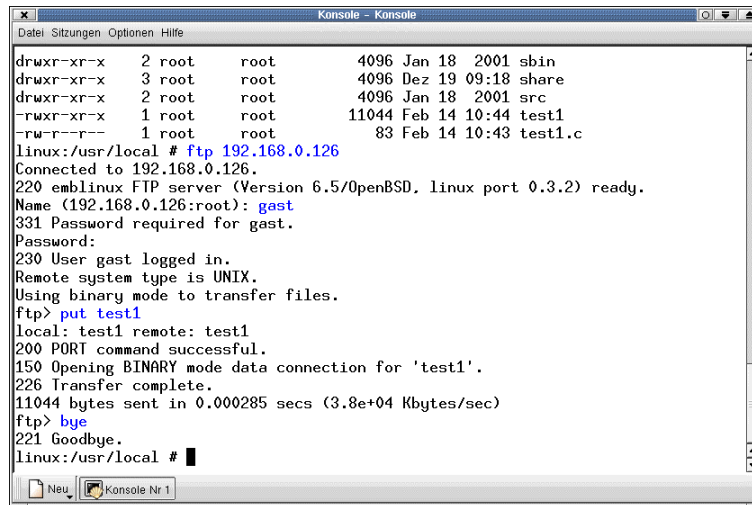

```

Datei Sitzungen Optionen Hilfe
drwxr-xr-x  2 root   root    4096 Jan 18  2001 sbin
drwxr-xr-x  3 root   root    4096 Dez 19  09:18 share
drwxr-xr-x  2 root   root    4096 Jan 18  2001 src
-rwxr-xr-x  1 root   root    11044 Feb 14 10:44 test1
-rw-r--r--  1 root   root     83 Feb 14 10:43 test1.c
linux:/usr/local # ftp 192.168.0.126
Connected to 192.168.0.126.
220 emblinux FTP server (Version 6.5/OpenBSD, linux port 0.3.2) ready.
Name (192.168.0.126:root): gast
331 Password required for gast.
Password:
230 User gast logged in.
Remote system type is UNIX.
Using binary mode to transfer files.
ftp> put test1
local: test1 remote: test1
200 PORT command successful.
150 Opening BINARY mode data connection for 'test1'.
226 Transfer complete.
11044 bytes sent in 0.000285 secs (3.8e+04 Kbytes/sec)
ftp> bye
221 Goodbye.
linux:/usr/local #

```

Figure 43: File transfer with FTP

Please note: During the FTP file transfer process the executable attribute of *test1* can get lost. Without this attribute it is not possible to execute this file. Some FTP clients watch the attributes. In this case you can skip the next step.

To restore the executable attribute (lost by the FTP transfer) enter the command line:

chmod +x test1

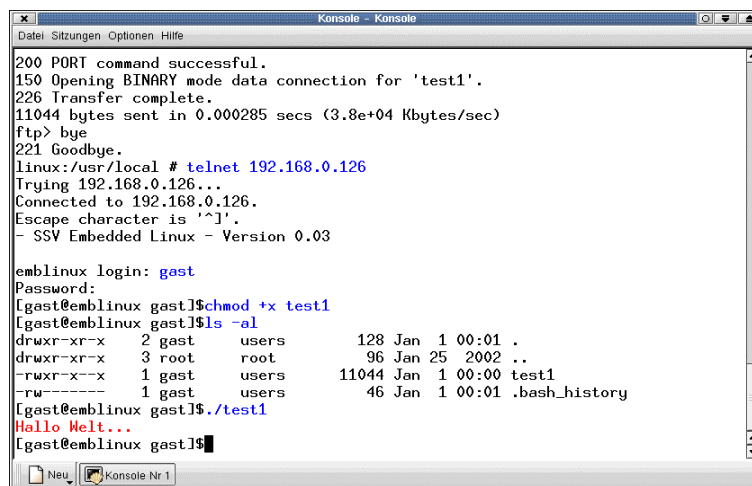

```

Datei Sitzungen Optionen Hilfe
200 PORT command successful.
150 Opening BINARY mode data connection for 'test1'.
226 Transfer complete.
11044 bytes sent in 0.000285 secs (3.8e+04 Kbytes/sec)
ftp> bye
221 Goodbye.
linux:/usr/local # telnet 192.168.0.126
Trying 192.168.0.126...
Connected to 192.168.0.126.
Escape character is '^['.
- SSV Embedded Linux - Version 0.03

emblinux login: gast
Password:
[gast@emblinux gast]$chmod +x test1
[gast@emblinux gast]$ls -al
drwxr-xr-x  2 gast   users    128 Jan  1  00:01 .
drwxr-xr-x  3 root   root     96 Jan 25  2002 ..
-rwxr-xr-x  1 gast   users   11044 Jan  1  00:00 test1
-rw-----  1 gast   users     46 Jan  1  00:01 .bash_history
[gast@emblinux gast]$./test1
Hallo Welt...
[gast@emblinux gast]$

```

Figure 44: Telnet Session

After the executable attribute was reassigned you should check the correct status with the command *ls -al*. Now you will see the content of the directory named *gast*. To execute the transferred and assembled file please type in:

./test1

The file will now be executed and deliver the output "Hallo Welt..." to you.

For the assembling of a C-program the gcc will normally be activated by using a so-called makefile.

```
CROSS      = /usr/local/arm/2.95.2/bin/arm-linux-  
CC         = $(CROSS)gcc  
CFLAGS     = -Wall -O2 -march=armv4 -mtune=strongarm  
LFLAGS     = -Wl,-s  
  
$(PROJ):   $(PROJ).c Makefile  
           $(CC) $(CFLAGS) $(PROJ).c -o $(PROJ) $(LFLAGS)  
clean:  
           rm -f $(PROJ)
```

All required parameters needed to create the desired binary file are stored in such a makefile.

6. Troubleshooting

This page shows problems that can be corrected by users. If a problem persists after trying these solutions, please contact SSV Embedded Systems.

Phenomenom	Probable Cause	Reference
No power to the system at all. Power light does not illuminate.	Power cable is unplugged	Make sure power cable is securely plugged in.
	Power supply failure.	Contact technical support.
	Defective power cable.	Contact technical support.
	Incorrect polarity.	Make sure polarity of the cable matched with polarity from connector.
Screen is blank.	No power to display.	Check the CFL power cable connection to backlight converter and system. Check the connection between display and backlight converter.
	Display not connected to LCD connector.	Make sure display is connected to LCD connector.
Lines on the display.	No LCD power management.	No error. Picture will appear in a few seconds.
Wrong colors on display.	Wrong DIP-switch settings.	Check DIP-switch settings.
Missing lines on display	Defective LCD cable.	Check LCD cable.
No boot messages.	RCM jumper is not set.	Open RCM jumper will block all boot messages

7. Appendix

The Appendixes 1 to 4 give you more detailed informations about the signals on the individual connectors. Table cells marked with NC indicate signals, which may be not connected.

Appendix 1: Pin Assignment PNP/1110

The 169 pins of the PGA socket are associated to 17 lines and 17 columns. The individual lines are allocated to digits; letters localizes the columns.

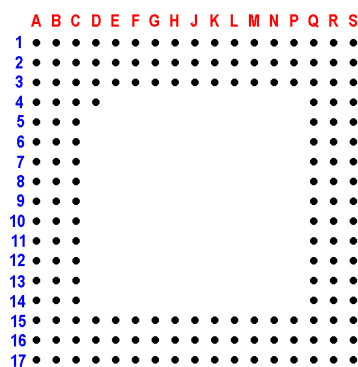

Figure 45: PNP/1110 Pin Side View

The tables 2-18 show the pinout of the PNP/1110 and the corresponding pins on the SA-1110. Please consider, that the notation of letters is not continuous. The letters „I“ and „O“ are not be provided.

Pin	Name	Function	SA-1110 Signal
A1	RX-	Ethernet LAN Interface, RX-	–
A2	TX-	Ethernet LAN Interface, TX-	–
A3	NC	Reserved - Don't use	–
A4	NC	Reserved - Don't use	–
A5	TMS	JTAG Interface, TMS Signal	TMS
A6	TDI	JTAG Interface, TDI Signal	TDI
A7	TRST	JTAG Interface, TRST Signal (Low-active)	nTRST
A8	SA24	Expansion Bus, Address Bit 24	A24
A9	SA22	Expansion Bus, Address Bit 22	A22
A10	SA20	Expansion Bus, Address Bit 20	A20
A11	SA18	Expansion Bus, Address Bit 18	A18
A12	SA16	Expansion Bus, Address Bit 16	A16
A13	SA13	Expansion Bus, Address Bit 13	A13
A14	SA10	Expansion Bus, Address Bit 10	A10
A15	SA8	Expansion Bus, Address Bit 8	A8
A16	SA7	Expansion Bus, Address Bit 7	A7
A17	SA6	Expansion Bus, Address Bit 6	A6

Table 2: Pin assignment PNP/1110 pin A1 to A17

Pin	Name	Function	SA-1110 Signal
B1	RX+	Ethernet LAN Interface, RX+	–
B2	TX+	Ethernet LAN Interface, TX+	–
B3	NC	Reserved - Don't use	–
B4	NC	Reserved - Don't use	–
B5	TCK	JTAG Interface, TCK Signal	TCK
B6	TDO	JTAG Interface, TDO Signal	TDO
B7	SA25	Expansion Bus, Address Bit 25	A25
B8	SA23	Expansion Bus, Address Bit 23	A23
B9	SA21	Expansion Bus, Address Bit 21	A21
B10	SA19	Expansion Bus, Address Bit 19	A19
B11	SA17	Expansion Bus, Address Bit 17	A17
B12	SA15	Expansion Bus, Address Bit 15	A15
B13	SA12	Expansion Bus, Address Bit 12	A12
B14	SA9	Expansion Bus, Address Bit 9	A9
B15	SA5	Expansion Bus, Address Bit 5	A5
B16	SA3	Expansion Bus, Address Bit 3	A3
B17	SA4	Expansion Bus, Address Bit 4	A4

Table 3: Pin assignment PNP/1110 pin B1 to B17

Pin	Name	Function	SA-1110 Signal
C1	TXD1	COM1 Serial Port, TXD Pin	TXD_1
C2	RXD1	COM1 Serial Port, RXD Pin	RXD_1
C3	VBAT	Real Time Clock Battery Input	–
C4	GND	Ground	–
C5	RCME	Remote Console Mode Enable (Low-active)	RXD_2
C6	VCC	3.3 Volt Power Input	–
C7	GND	Ground	–
C8	GND	Ground	–
C9	GND	Ground	–
C10	GND	Ground	–
C11	GND	Ground	–
C12	VCC	3.3 Volt Power Input	–
C13	SA14	Expansion Bus, Address Bit 14	A14
C14	SA11	Expansion Bus, Address Bit 11	A11
C15	SA2	Expansion Bus, Address Bit 2	A2
C16	SA0	Expansion Bus, Address Bit 0	A0
C17	SA1	Expansion Bus, Address Bit 1	A1

Table 4: Pin assignment PNP/1110 pin C1 to C17

Pin	Name	Function	SA-1110 Signal
D1	TXD2	COM2 Serial Port, TXD Pin	TXD_3
D2	RXD2	COM2 Serial Port, RXD Pin	RXD_3
D3	GND	Ground	–
D4	GND	Ground	–
D15	CS3	Chip Select Output 3 (Low-active)	nCS3
D16	CS1	Chip Select Output 1 (Low-active)	nCS1
D17	CS2	Chip Select Output 2 (Low-active)	nCS2

Table 5: Pin assignment PNP/1110 pin D1 to D17

Pin	Name	Function	SA-1110 Signal
E1	LCD.D14	LCD Controller, Data Bit 14 (alternative INT4, if LCD in 8-bit mode)	GP8
E2	LCD.D13	LCD Controller, Data Bit 13 (alternative INT3, if LCD in 8-bit mode)	GP7
E3	LCD.D15	LCD Controller, Data Bit 15 (alternative INT5, if LCD in 8-bit mode)	GP9
E15	RDY	External Ready Input	RDY
E16	CS4	Chip Select Output 4 (Low-active)	nCS4
E17	CS5	Chip Select Output 5 (Low-active)	nCS5

Table 6: Pin assignment PNP/1110 pin E1 to E17

Pin	Name	Function	SA-1110 Signal
F1	LCD.D12	LCD Controller, Data Bit 12 (alternative INT2, if LCD in 8-bit mode)	GP6
F2	LCD.D11	LCD Controller, Data Bit 11	GP5
F3	VCC	3.3 Volt Power Input	–
F15	VCC	3.3 Volt Power Input	–
F16	OE	Expansion Bus, Output Enable (Output - Low-active)	nOE
F17	WE	Expansion Bus, Write Enable (Output - Low-active)	nWE

Table 7: Pin assignment PNP/1110 pin F1 to F17

Pin	Name	Function	SA-1110 Signal
G1	LCD.D10	LCD Controller, Data Bit 10	GP4
G2	LCD.D9	LCD Controller, Data Bit 9	GP3
G3	GND	Ground	–
G15	GND	Ground	–
G16	PCC.OE	PC Card Interface, Output Enable (Output -Low-active)	nPOE
G17	PCC.WE	PC Card Interface, Write Enable (Output -Low-active)	nPWE

Table 8: Pin assignment PNP/1110 pin G1 to G17

Pin	Name	Function	SA-1110 Signal
H1	LCD.D8	LCD Controller, Data Bit 8	GP2
H2	LCD.D7	LCD Controller, Data Bit 7	LDD7
H3	GND	Ground	–
H15	GND	Ground	–
H16	PCC.IOR	PC Card Interface, I/O Read (Output - Low-active)	nPIOR
H17	PCC.IOW	PC Card Interface, I/O Write (Output - Low-active)	nPIOW

Table 9: Pin assignment PNP/1110 pin H1 to H17

Pin	Name	Function	SA-1110 Signal
J1	LCD.D6	LCD Controller, Data Bit 6	LDD6
J2	LCD.D5	LCD Controller, Data Bit 5	LDD5
J3	GND	Ground	–
J15	GND	Ground	–
J16	PCC. WAIT	PC Card Interface, WAIT Signal (Input - Low-active)	–
J17	PCC. REG	PC Card Interface, REG Signal (Output - Low-active)	nPREG

Table 10: Pin assignment PNP/1110 pin J1 to J17

Pin	Name	Function	SA-1110 Signal
K1	LCD.D4	LCD Controller, Data Bit 4	LDD4
K2	LCD.D3	LCD Controller, Data Bit 3	LDD3
K3	GND	Ground	–
K15	GND	Ground	–
K16	PCC. IOCS16	PC Card Interface, IOCS16 Signal (Input -Low-active)	NIOIS16
K17	PCC. SKTSEL	PC Card Interface, SKTSEL Signal (Output)	PSKTSEL

Table 11: Pin assignment PNP/1110 pin K1 to K17

Pin	Name	Function	SA-1110 Signal
L1	LCD.D2	LCD Controller, Data Bit 2	LDD2
L2	LCD.D1	LCD Controller, Data Bit 1	LDD1
L3	GND	Ground	–
L15	GND	Ground	–
L16	PCC.CE1	PC Card Interface, Chip Enable 1 (Output - Low-active)	nPCE1
L17	PCC.CE2	PC Card Interface, Chip Enable 2 (Output - Low-active)	nPCE2

Table 12: Pin assignment PNP/1110 pin L1 to L17

Pin	Name	Function	SA-1110 Signal
M1	LCD.D0	LCD Controller, Data Bit 0	LDD0
M2	LCD.BIAS	LCD Controller, BIAS Signal (TFT Data Enable)	L_BIAS
M3	VCC	3.3 Volt Power Input	–
M15	VCC	3.3 Volt Power Input	–
M16	RD/WR	Read/Write Signal (Output - Write is Low- active)	RD_nWR
M17	INT1	Interrupt Input 1	GP1

Table 13: Pin assignment PNP/1110 pin M1 to M17

Pin	Name	Function	SA-1110 Signal
N1	LCD. PCLK	LCD Controller, PCLK Signal (TFT Pixel Clock)	L_PCLK
N2	LCD. LCLK	LCD Controller, LCLK Signal (TFT HSYNC)	L_LCLK
N3	LCD. FCLK	LCD Controller, FCLK Signal (TFT VSYNC)	L_FCLK
N15	CLKOUT	Clock Output (Default 3.6864 MHz)	GP27
N16	RESIN	RESET Input (Low-active)	–
N17	RESOUT	RESET Output (Low-active)	nRESET_OUT

Table 14: Pin assignment PNP/1110 pin N1 to N17

Pin	Name	Function	SA-1110 Signal
P1	PC2	Parallel I/O, Port C, Bit 2	SCLK_C
P2	PC1	Parallel I/O, Port C, Bit 1	RXD_C
P3	PC3	Parallel I/O, Port C, Bit 3	SFRM_C
P15	SD2	Expansion Bus, Data Bit 2	D2
P16	SD0	Expansion Bus, Data Bit 0	D0
P17	SD1	Expansion Bus, Data Bit 1	D1

Table 15: Pin assignment PNP/1110 pin P1 to P17

Pin	Name	Function	SA-1110 Signal
Q1	PC0	Parallel I/O, Port C, Bit 0	TXD_C
Q2	PB2	Parallel I/O, Port B, Bit 2	GP18
Q3	PB5	Parallel I/O, Port B, Bit 5	GP21
Q4	PA5	Parallel I/O, Port A, Bit 5	GP15
Q5	PA2	Parallel I/O, Port A, Bit 2	GP12
Q6	VCC	3.3 Volt Power Input	–
Q7	GND	Ground	–
Q8	GND	Ground	–
Q9	GND	Ground	–
Q10	GND	Ground	–
Q11	GND	Ground	–
Q12	VCC	3.3 Volt Power Input	–
Q13	SD17	Expansion Bus, Data Bit 17	D17
Q14	SD14	Expansion Bus, Data Bit 14	D14
Q15	SD5	Expansion Bus, Data Bit 5	D5
Q16	SD3	Expansion Bus, Data Bit 3	D3
Q17	SD4	Expansion Bus, Data Bit 4	D4

Table 16: Pin assignment PNP/1110 pin Q1 to Q17

Pin	Name	Function	SA-1110 Signal
R1	PB0	Parallel I/O, Port B, Bit 0	GP16
R2	PB4	Parallel I/O, Port B, Bit 4	GP20
R3	PB7	Parallel I/O, Port B, Bit 7	GP23
R4	PA3	Parallel I/O, Port A, Bit 3	GP13
R5	PA0	Parallel I/O, Port A, Bit 0	GP10
R6	SD30	Expansion Bus, Data Bit 30	D30
R7	SD28	Expansion Bus, Data Bit 28	D28
R8	SD26	Expansion Bus, Data Bit 26	D26
R9	SD24	Expansion Bus, Data Bit 24	D24
R10	SD22	Expansion Bus, Data Bit 22	D22
R11	SD20	Expansion Bus, Data Bit 20	D20
R12	SD18	Expansion Bus, Data Bit 18	D18
R13	SD15	Expansion Bus, Data Bit 15	D15
R14	SD12	Expansion Bus, Data Bit 12	D12
R15	SD8	Expansion Bus, Data Bit 8	D8
R16	SD6	Expansion Bus, Data Bit 6	D6
R17	SD7	Expansion Bus, Data Bit 7	D7

Table 17: Pin assignment PNP/1110 pin R1 to R17

Pin	Name	Function	SA-1110 Signal
S1	PB1	Parallel I/O, Port B, Bit 1	GP17
S2	PB3	Parallel I/O, Port B, Bit 3	GP19
S3	PB6	Parallel I/O, Port B, Bit 6	GP22
S4	PA4	Parallel I/O, Port A, Bit 4	GP14
S5	PA1	Parallel I/O, Port A, Bit 1	GP11
S6	SD31	Expansion Bus, Data Bit 31	D31
S7	SD29	Expansion Bus, Data Bit 29	D29
S8	SD27	Expansion Bus, Data Bit 27	D27
S9	SD25	Expansion Bus, Data Bit 25	D25
S10	SD23	Expansion Bus, Data Bit 23	D23
S11	SD21	Expansion Bus, Data Bit 21	D21
S12	SD19	Expansion Bus, Data Bit 19	D19
S13	SD16	Expansion Bus, Data Bit 16	D16
S14	SD13	Expansion Bus, Data Bit 13	D13
S15	SD11	Expansion Bus, Data Bit 11	D11
S16	SD10	Expansion Bus, Data Bit 10	D10
S17	SD9	Expansion Bus, Data Bit 9	D9

Table 18: Pin assignment PNP/1110 pin S1 to S17

Appendix 2: Pin Assignment DNP/EVA4 Components

CFL Connector

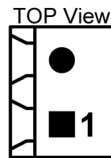

Pin	Name	Signal
1	VCC	Power Out
2	GND	Power

Table 19: Pinout CFL Connector

LCD Connector

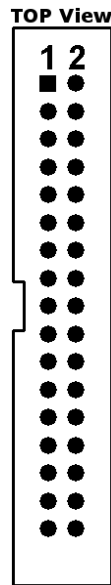

Pin	Name	Signal
1	GND	Power
2	CLK	Pixel Clock
3	HSYNC	Horizontal Sync.
4	VSYNC	Vertical Sync.
5	GND	Power
6	R0	---
7	R1	RED 1
8	R2	RED 2
9	R3	RED 3
10	R4	RED 4
11	R5	RED 5
12	GND	Power
13	G0	GREEN 0
14	G1	GREEN 1
15	G2	GREEN 2
16	G3	GREEN 3
17	G4	GREEN 4
18	G5	GREEN 5
19	GND	Power
20	B0	---
21	B1	BLUE 1
22	B2	BLUE 2
23	B3	BLUE 3
24	B4	BLUE 4
25	B5	BLUE 5
26	GND	Power
27	DE	Data Enable
28	VCC	Power
29	VCC	Power
30	nc.	---
31	DPS	---
32	nc	---
33	nc	---
34	nc	---

Table 20: Pinout LCD Connector

COM1 Connector

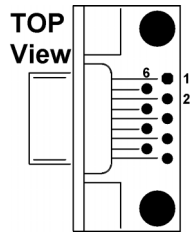

Pin	Signal
1	nc
2	RxD
3	TxD
4	nc
5	GND

Pin	Signal
6	nc
7	nc
8	nc
9	nc

Table 21: Pinout COM1 Connector

COM2 Connector

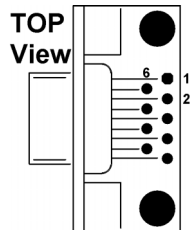

Pin	Signal
1	nc
2	RxD
3	TxD
4	nc/5V*
5	GND

Pin	Signal
6	nc
7	nc/5V*
8	nc
9	nc

* switchable (see Chapter 3.11 and 3.12)

Table 22: Pinout COM2 Connector

10/100 Mbps Ethernet Connector

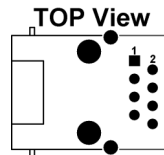

Pin	Name	Signal
1	TX+	TXD+
2	TX-	TXD-
3	RX+	RXD+
4	nc	---
5	nc	---
6	RX-	RXD-
7	nc	---
8	nc	---
S1..2	Shield	---

Table 23: Pinout 10/100 Mbps Connector

JTAG Connector

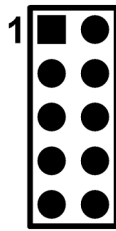

Pin	Name	Signal
1	TDI	JTAG Test Data In
2	TDO	JTAG Test Data Out
3	TMS	JTAG Test Mode Select
4	GND	Power
5	TRST#	JTAG Test Reset
6	TCK	JTAG Test Clock
7	VCC	Power (3.3V)
8	nc	---
9	WD Disable	nc
10	GND	Power

Table 24: Pinout JTAG Connector

Power Connector

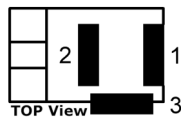

Pin	Name	Signal
1	VCC	Power In
2	GND	Power
3	GND	Power

Table 25: Pinout Power Connector

RCM Jumper



Jumper	Function
open	Disable RCM mode for PNP/1110
close	Enable RCM mode for PNP/1110

Table 26: RCM Jumper Settings

COM2 Power Switch Jumper JP2



Jumper	Function
open	COM2 RTS and DTR not connected
close	COM2 RTS and DTR tied to +5V

Table 27: Pinout Power Connector

Appendix 3: PNP/1110 Memory Map

Physical Address	Description	Virtual Address	Read	Write	Cached	Buffered
0x00000000-0x07FFFFFFF	Boot-Flash	0xE8000000-0xEFFFFFFF	Y	Y	N	N
0x28000000-0x2FFFFFFF	Ethernet	not mapped	Y	Y	N	N
0x08000000-0x0FFFFFFF	external Device at CS1	not mapped	Y	Y	N	N
0x10000000-0x17FFFFFFF	external Device at CS2	not mapped	Y	Y	N	N
0x18000000-0x1FFFFFFF	external Device at CS3	not mapped	Y	Y	N	N
0x40000000-0x47FFFFFFF	external Device at CS4	not mapped	Y	Y	N	N
0x48000000-0x4FFFFFFF	external Device at CS5	not mapped	Y	Y	N	N
0x80000000-0xB7FFFFFFF	SA-1110 int. Registers	0x80000000-0xB7FFFFFFF	Y	Y	N	N
0xC0000000-0xC7FFFFFFF	SDDRAM Bank 0	0x00000000-0x07FFFFFFF	Y	Y	Y	Y

Table 28: PNP/1110 Memory Map

Appendix 4: DIP-Switch Settings

DIP-Switch			LCD
A0	A1	A2	
OFF	OFF	OFF	640x480x16 bit (default)
ON	OFF	OFF	640x480x 8 bit*
OFF	ON	OFF	640x480x 4 bit*
ON	ON	OFF	800x600x 8 bit*
OFF	OFF	ON	800x600x 4 bit*
ON	OFF	ON	do not use
OFF	ON	ON	do not use
ON	ON	ON	do not use

*to use this setting an adapter is needed, please contact SSV Embedded Systems

Table 29: DIP-Switch Settings

Appendix 5: Interrupt Usage

Figure 46 shows, which interrupts are available on the related LCD mode.

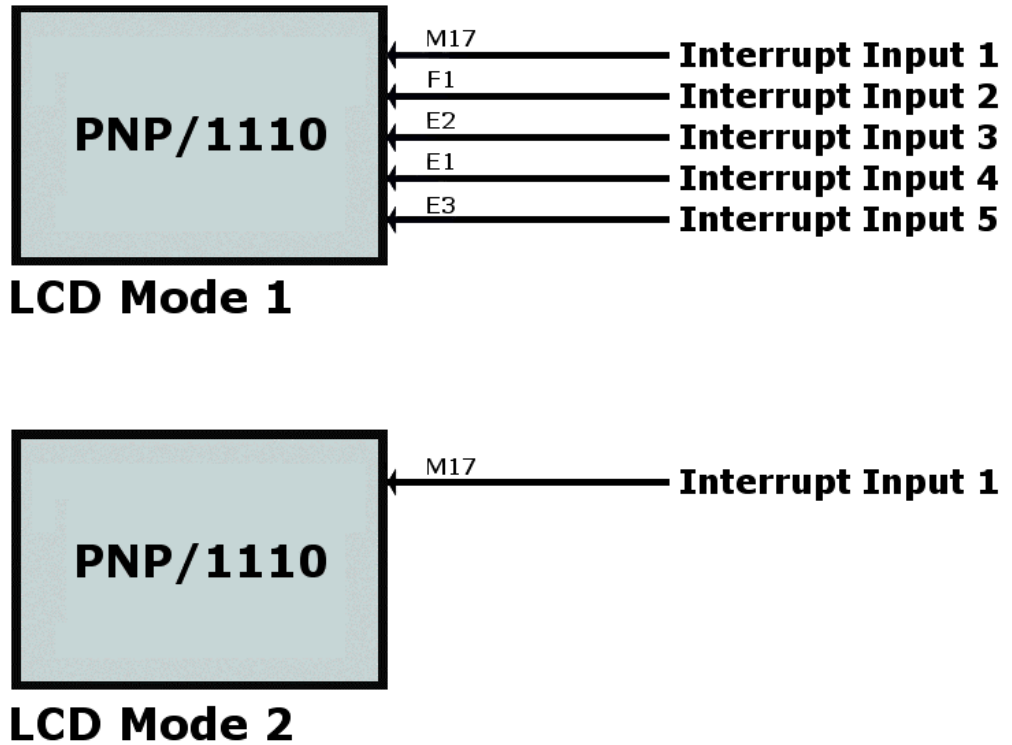

Figure 46: Interrupt Usage

Display Mode	Display Type	Available Interrupt
LCD Mode 1	<ul style="list-style-type: none"> TFT Color 4/8 Bit Color Single Scan Passive LCD Monochrome Passive LCD 	INT 1, 2 .. 5
LCD Mode 2	<ul style="list-style-type: none"> TFT 16 Bit Color Dual Scan Passive 	INT 1

Table 30: Interrupt Usage

Appendix 6: The RCME (RCM Enable) Jumper

To enable the RCM mode of the PNP/1110, connect a jumper as well as a pull-down resistor on pin C5 and use it like shown in figure 47.

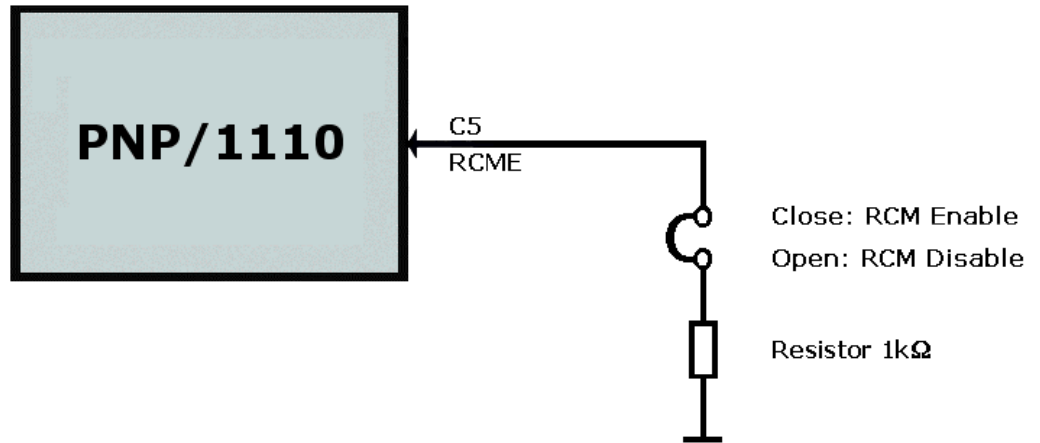

Figure 47: RCME Jumper

Appendix 7: The PNP/1110 Clock Output

The Clock Output (CLKOUT) frequency of 3.6864 MHz is generated by the internal PLL of the SA-1110 microcontroller.

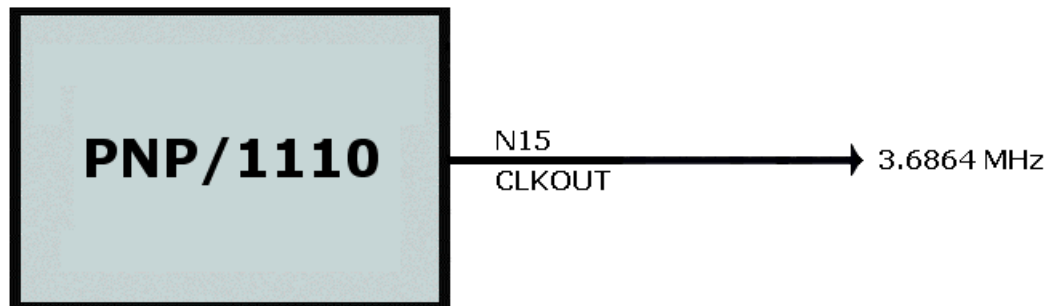

Figure 48: PNP/1110 Clock Output

Appendix 8: Using the SA-1110 Serial Channels

The PNP/1110 features five serial channels (SIO Ch 0 .. SIO Ch 4). Serial Channel 4 alias Port C is free for use. Serial channel 0,1 and 3 are connected like shown in figure 49.

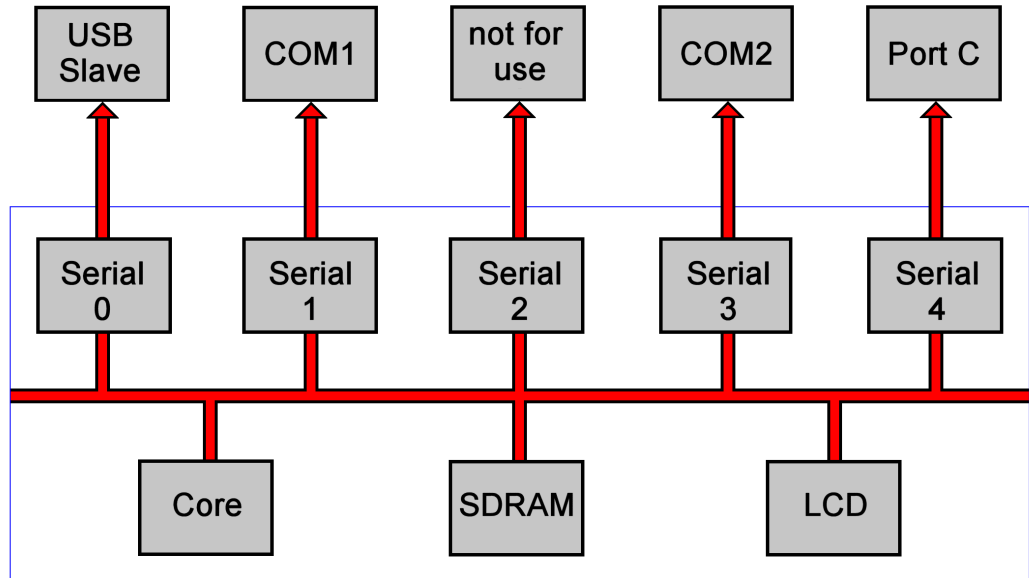

Figure 49: PNP/1110 Serial Channels

Note: Serial channel 0 is not connected outside. Serial channel 2 is completely used internal and not connected outside; please do not use this channel.

Appendix 9: Using the Compact Flash (CF)-Interface

The PNP/1110 offers the possibility to connect a Compact Flash (CF) adapter to realize different system expansions. Figure 50 shows a general diagram how to connect a CF-interface onto the PNP/1110.

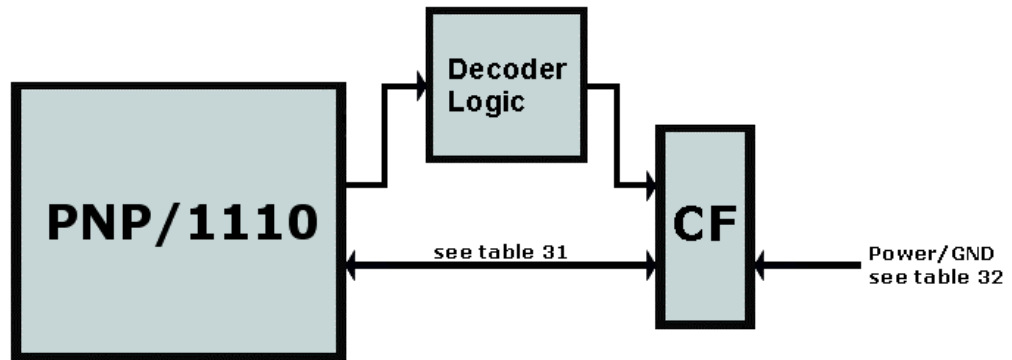

Figure 50: PNP/1110 CF-Interface Connection

This chapter describes only one possible capability to connect an 8-bit CF-interface. This interface is running in memory mode. For the memory mode SSV Embedded System offers a Linux device driver. For more information please contact SSV. Table 31 shows which connections have to be made between the pins of the PNP/1110 and the 8-bit Compact Flash interface. The necessary connections between the CF-interface and Power/Ground are shown in table 32.

From	To	Function
PNP/1110 Pin	CF Pin	
P16	21	Data 0
P17	22	Data 1
P15	23	Data 2
Q16	2	Data 3
Q17	3	Data 4
Q15	4	Data 5
R16	5	Data 6
R17	6	Data 7
C16	20	Addr. 0
C17	19	Addr. 1
C15	18	Addr. 2
B16	17	Addr. 3
H16	9	PCC.IOR#
H17	36	PCC.IOW#

Table 31: CF-Interface Pin Connections

In addition to the connections shown in table 31 there are some Power/GND connections necessary. You can see these connections on table 32.

Source		To		Function
		CF Pin		
GND		1, 50		Power (0V)
GND		8, 10..12, 14..16		A10, A9..7, A6..4
GND		39, 41		CSEL, RESET
VCC		13, 38		Power (3.3V)
VCC		32, 34, 35, 44		CE2#, IOR#, IOW#, REG#
NC		47..49, 27..31		D8..10, D11..15
NC		26, 25		CD1#, CD2#
NC		24, 33, 37, 40, 42, 43, 45, 46		WP, VS1, RDY/BSY, VS2, WAIT#, INPACK#, BVD2, BVS1

Table 32: CF-Interface Power/GND Connections

Some pins of the PNP/1110 have to be connected with a special decoder logic shown in figure 50. The decoder logic connections and its characteristic will be described in detail by figure 51 and table 33. Please note, that a connection from the decoder output to pin 7 of the CF-interface is needed.

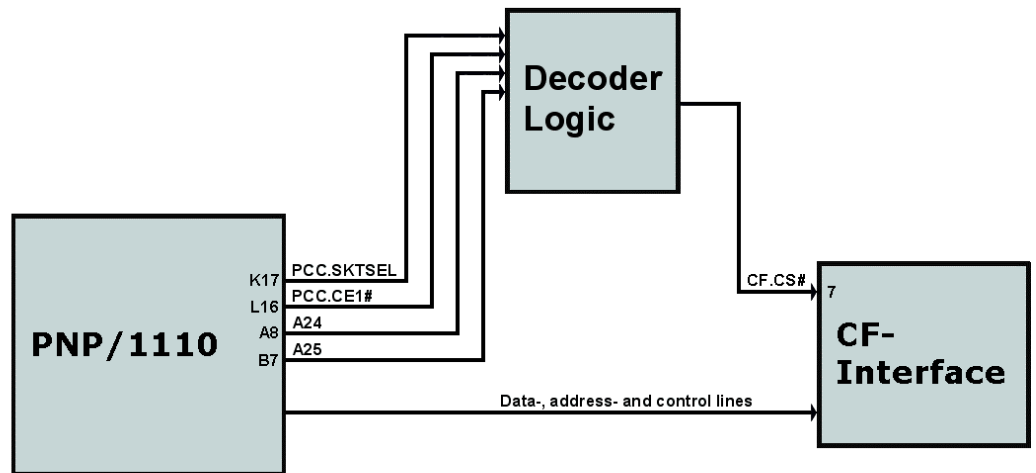

Figure 51: PNP/1110 Decoder Logic Connection

The decoder logic used to connect a Compact Flash interface to the PNP/1110 is realized with a 74HC138 component. Table 32 shows the standard settings.

Inputs						Outputs							
Enable			Select										
VCC	PCC.CE1#		PCC.SKTSEL	A25	A24					CS			
G1	G2A	G2B	C	B	A	Y0	Y1	Y2	Y3	Y4	Y5	Y6	Y7
X	H	X	X	X	X	H	H	H	H	H	H	H	H
X	X	H	X	X	X	H	H	H	H	H	H	H	H
L	X	X	X	X	X	H	H	H	H	H	H	H	H
H	L	L	L	L	L	L	H	H	H	H	H	H	H
H	L	L	L	L	H	H	L	H	H	H	H	H	H
H	L	L	L	H	L	H	H	L	H	H	H	H	H
H	L	L	L	H	H	H	H	H	L	H	H	H	H
H	L	L	H	L	L	H	H	H	H	L	H	H	H
H	L	L	H	L	H	H	H	H	H	H	L	H	H
H	L	L	H	H	L	H	H	H	H	H	H	L	H
H	L	L	H	H	H	H	H	H	H	H	H	H	L

Table 33: Decoder Characteristics

Note: To use our standard Compact Flash device driver for the PNP/1110 make sure that the used logic corresponds to the settings marked in table 32.

This interface does not support the so-called “hot plug in” mode. To use this mode a special logic is needed. Plugging cards into the card cage with power on will usually not cause a problem but you shouldn’t do this. However, the card may be damaged if the right sequence of pins contacts as the card is pushed into the socket. This may damage chips and they may become hot when power is applied. This is one of the most common failures of expansion cards.

Appendix 10: Mechanical Dimensions

The PNP/1110 uses a 169-pin PGA socket (Socket 3) as mechanical base. The figure 50 shows the dimensions. All length dimensions have a tolerance of 0.5 mm.

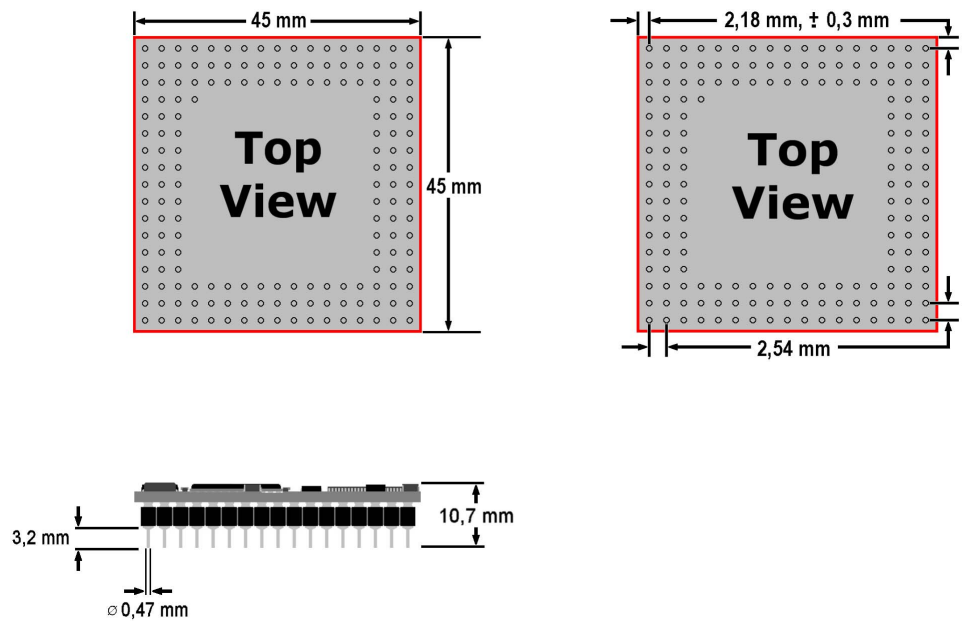

Figure 52: Dimensions of the PNP/1110

Appendix 11: GNU General Public License

GNU GENERAL PUBLIC LICENSE. Version 2, June 1991. Copyright © 1989, 1991 Free Software Foundation, Inc. 59 Temple Place, Suite 330, Boston, MA 02111-1307 USA. Everyone is permitted to copy and distribute verbatim copies of this license document, but changing it is not allowed.

Preamble

The licenses for most software are designed to take away your freedom to share and change it. By contrast, the GNU General Public License is intended to guarantee your freedom to share and change free software—to make sure the software is free for all its users. This General Public License applies to most of the Free Software Foundation’s software and to any other program whose authors commit to using it. (Some other Free Software Foundation software is covered by the GNU Library General Public License instead.) You can apply it to your programs, too.

When we speak of free software, we are referring to freedom, not price. Our General Public Licenses are designed to make sure that you have the freedom to distribute copies of free software (and charge for this service if you wish), that you receive source code or can get it if you want it, that you can change the software or use pieces of it in new free programs; and that you know you can do these things.

To protect your rights, we need to make restrictions that forbid anyone to deny you these rights or to ask you to surrender the rights. These restrictions translate to certain responsibilities for you if you distribute copies of the software, or if you modify it.

For example, if you distribute copies of such a program, whether gratis or for a fee, you must give the recipients all the rights that you have. You must make sure that they, too, receive or can get the source code. And you must show them these terms so they know their rights.

We protect your rights with two steps: (1) copyright the software, and (2) offer you this license which gives you legal permission to copy, distribute and/or modify the software.

Also, for each author’s protection and ours, we want to make certain that everyone understands that there is no warranty for this free software. If the software is modified by someone else and passed on, we want its recipients to know that what they have is not the original, so that any problems introduced by others will not reflect on the original authors’ reputations. Finally, any free program is threatened constantly by software patents. We wish to avoid the danger that redistributors of a free program will individually obtain patent licenses, in effect making the program proprietary. To prevent this, we have made it clear that any patent must be licensed for everyone’s free use or not licensed at all.

The precise terms and conditions for copying, distribution and modification follow.

GNU GENERAL PUBLIC LICENSE. TERMS AND CONDITIONS FOR COPYING, DISTRIBUTION AND MODIFICATION

1. This License applies to any program or other work which contains a notice placed by the copyright holder saying it may be distributed under the terms of this General Public License. The “Program”, below, refers to any such program or work, and a “work based on the Program” means either the Program or any derivative work under copyright law: that is to say, a work containing the Program or a portion of it, either verbatim or with modifications and/or translated into another language. (Hereinafter, translation is included without limitation in the term “modification”.) Each license is addressed as “you”.

Activities other than copying, distribution and modification are not covered by this License; they are outside its scope. The act of running the Program is not restricted, and the output from the Program is covered only if its contents constitute a work based on the Program (independent of having been made by running the Program). Whether that is true depends on what the Program does.

1. You may copy and distribute verbatim copies of the Program's source code as you receive it, in any medium, provided that you conspicuously and appropriately publish on each copy an appropriate copyright notice and disclaimer of warranty; keep intact all the notices that refer to this License and to the absence of any warranty; and give any other recipients of the Program a copy of this License along with the Program.

You may charge a fee for the physical act of transferring a copy, and you may at your option offer warranty protection in exchange for a fee.

2. You may modify your copy or copies of the Program or any portion of it, thus forming a work based on the Program, and copy and distribute such modifications or work under the terms of Section 1 above, provided that you also meet all of these conditions:

1. You must cause the modified files to carry prominent notices stating that you changed the files and the date of any change.

b) You must cause any work that you distribute or publish, that in whole or in part contains or is derived from the Program or any part thereof, to be licensed as a whole at no charge to all third parties under the terms of this License.

c) If the modified program normally reads commands interactively when run, you must cause it, when started running for such interactive use in the most ordinary way, to print or display an announcement including an appropriate copyright notice and a notice that there is no warranty (or else, saying that you provide a warranty) and that users may redistribute the program under these conditions, and telling the user how to view a copy of this License. (Exception: if the Program itself is interactive but does not normally print such an announcement, your work based on the Program is not required to print an announcement.)

These requirements apply to the modified work as a whole. If identifiable sections of that work are not derived from the Program, and can be reasonably considered independent and separate works in themselves, then this License, and its terms, do not apply to those sections when you distribute them as separate works. But when you distribute the same sections as part of a whole which is a work based on the Program, the distribution of the whole must be on the terms of this License, whose permissions for other licensees extend to the entire whole, and thus to each and every part regardless of who wrote it.

Thus, it is not the intent of this section to claim rights or contest your rights to work written entirely by you; rather, the intent is to exercise the right to control the distribution of derivative or collective works based on the Program.

In addition, mere aggregation of another work not based on the Program with the Program (or with a work based on the Program) on a volume of a storage or distribution medium does not bring the other work under the scope of this License.

3. You may copy and distribute the Program (or a work based on it, under Section 2) in object code or executable form under the terms of Sections 1 and 2 above provided that you also do one of the following:

1. Accompany it with the complete corresponding machine-readable source code, which must be distributed under the terms of Sections 1 and 2 above on a medium customarily used for software interchange; or,
- b) Accompany it with a written offer, valid for at least three years, to give any third party, for a charge no more than your cost of physically performing source distribution, a

complete machine-readable copy of the corresponding source code, to be distributed under the terms of Sections 1 and 2 above on a medium customarily used for software interchange; or,

c) Accompany it with the information you received as to the offer to distribute corresponding source code. (This alternative is allowed only for noncommercial distribution and only if you received the program in object code or executable form with such an offer, in accord with Subsection b above.)

The source code for a work means the preferred form of the work for making modifications to it. For an executable work, complete source code means all the source code for all modules it contains, plus any associated interface definition files, plus the scripts used to control compilation and installation of the executable. However, as a special exception, the source code distributed need not include anything that is normally distributed (in either source or binary form) with the major components (compiler, kernel, and so on) of the operating system on which the executable runs, unless that component itself accompanies the executable.

If distribution of executable or object code is made by offering access to copy from a designated place, then offering equivalent access to copy the source code from the same place counts as distribution of the source code, even though third parties are not compelled to copy the source along with the object code.

4. You may not copy, modify, sublicense, or distribute the Program except as expressly provided under this License. Any attempt otherwise to copy, modify, sublicense or distribute the Program is void, and will automatically terminate your rights under this License.

However, parties who have received copies, or rights, from you under this License will not have their licenses terminated so long as such parties remain in full compliance.

5. You are not required to accept this License, since you have not signed it. However, nothing else grants you permission to modify or distribute the Program or its derivative works. These actions are prohibited by law if you do not accept this License. Therefore, by modifying or distributing the Program (or any work based on the Program), you indicate your acceptance of this License to do so, and all its terms and conditions for copying, distributing or modifying the Program or works based on it.

6. Each time you redistribute the Program (or any work based on the Program), the recipient automatically receives a license from the original licensor to copy, distribute or modify the Program subject to these terms and conditions. You may not impose any further restrictions on the recipients' exercise of the rights granted herein.

You are not responsible for enforcing compliance by third parties to this License.

1. If, as a consequence of a court judgment or allegation of patent infringement or for any other reason (not limited to patent issues), conditions are imposed on you (whether by court order, agreement or otherwise) that contradict the conditions of this License, they do not excuse you from the conditions of this License. If you cannot distribute so as to satisfy simultaneously your obligations under this License and any other pertinent obligations, then as a consequence you may not distribute the Program at all. For example, if a patent license would not permit royalty-free redistribution of the Program by all those who receive copies directly or indirectly through you, then the only way you could satisfy both it and this License would be to refrain entirely from distribution of the Program.

If any portion of this section is held invalid or unenforceable under any particular circumstance, the balance of the section is intended to apply and the section as a whole is intended to apply in other circumstances.

It is not the purpose of this section to induce you to infringe any patents or other property right claims or to contest validity of any such claims; this section has the sole purpose of

protecting the integrity of the free software distribution system, which is implemented by public license practices. Many people have made generous contributions to the wide range of software distributed through that system in reliance on consistent application of that system; it is up to the author/donor to decide if he or she is willing to distribute software through any other system and a licensee cannot impose that choice.

This section is intended to make thoroughly clear what is believed to be a consequence of the rest of this License.

1. If the distribution and/or use of the Program is restricted in certain countries either by patents or by copyrighted interfaces, the original copyright holder who places the Program under this License may add an explicit geographical distribution limitation excluding those countries, so that distribution is permitted only in or among countries not thus excluded. In such case, this License incorporates the limitation as if written in the body of this License.
1. The Free Software Foundation may publish revised and/or new versions of the General Public License from time to time. Such new versions will be similar in spirit to the present version, but may differ in detail to address new problems or concerns.

Each version is given a distinguishing version number. If the Program specifies a version number of this License which applies to it and “any later version”, you have the option of following the terms and conditions either of that version or of any later version published by the Free Software Foundation. If the Program does not specify a version number of this License, you may choose any version ever published by the Free Software Foundation.

10. If you wish to incorporate parts of the Program into other free programs whose distribution conditions are different, write to the author to ask for permission. For software which is copyrighted by the Free Software Foundation, write to the Free Software Foundation; we sometimes make exceptions for this. Our decision will be guided by the two goals of preserving the free status of all derivatives of our free software and of promoting the sharing and reuse of software generally.

NO WARRANTY

11. BECAUSE THE PROGRAM IS LICENSED FREE OF CHARGE, THERE IS NO WARRANTY FOR THE PROGRAM, TO THE EXTENT PERMITTED BY APPLICABLE LAW. EXCEPT WHEN OTHERWISE STATED IN WRITING THE COPYRIGHT HOLDERS AND/OR OTHER PARTIES PROVIDE THE PROGRAM “AS IS” WITHOUT WARRANTY OF ANY KIND, EITHER EXPRESSED OR IMPLIED, INCLUDING, BUT NOT LIMITED TO, THE IMPLIED WARRANTIES OF MERCHANTABILITY AND FITNESS FOR A PARTICULAR PURPOSE. THE ENTIRE RISK AS TO THE QUALITY AND PERFORMANCE OF THE PROGRAM IS WITH YOU. SHOULD THE PROGRAM PROVE DEFECTIVE, YOU ASSUME THE COST OF ALL NECESSARY SERVICING, REPAIR OR CORRECTION.

12. IN NO EVENT UNLESS REQUIRED BY APPLICABLE LAW OR AGREED TO IN WRITING WILL ANY COPYRIGHT HOLDER, OR ANY OTHER PARTY WHO MAY MODIFY AND/OR REDISTRIBUTE THE PROGRAM AS PERMITTED ABOVE, BE LIABLE TO YOU FOR DAMAGES, INCLUDING ANY GENERAL, SPECIAL, INCIDENTAL OR CONSEQUENTIAL DAMAGES ARISING OUT OF THE USE OR INABILITY TO USE THE PROGRAM (INCLUDING BUT NOT LIMITED TO LOSS OF DATA OR DATA BEING RENDERED INACCURATE OR LOSSES SUSTAINED BY YOU OR THIRD PARTIES OR A FAILURE OF THE PROGRAM TO OPERATE WITH ANY OTHER PROGRAMS), EVEN IF SUCH HOLDER OR OTHER PARTY HAS BEEN ADVISED OF THE POSSIBILITY OF SUCH DAMAGES.

END OF TERMS AND CONDITIONS

How to Apply These Terms to Your New Programs

If you develop a new program, and you want it to be of the greatest possible use to the public, the best way to achieve this is to make it free software which everyone can redistribute and change under these terms.

To do so, attach the following notices to the program. It is safest to attach them to the start of each source file to most effectively convey the exclusion of warranty; and each file should have at least the “copyright” line and a pointer to where the full notice is found.

<one line to give the program’s name and a brief idea of what it does.>
Copyright © <year> <name of author>

This program is free software; you can redistribute it and/or modify it under the terms of the GNU General Public License as published by the Free Software foundation; either version 2 of the License, or (at your option) any later version.

This program is distributed in the hope that it will be useful, but WITHOUT ANY WARRANTY; without even the implied warranty of MERCHANTABILITY or FITNESS FOR A PARTICULAR PURPOSE. See the GNU General Public License for more details.

You should have received a copy of the GNU General Public License along with this program; if not, write to the Free Software Foundation, Inc., 59 Temple Place, Suite 330, Boston, MA 02111-1307 USA

Also add information on how to contact you by electronic and paper mail.

If the program is interactive, make it output a short notice like this when it starts in an interactive mode:

Gnomovision version 69, Copyright © year name of author Gnomovision comes with ABSOLUTELY NO WARRANTY; for details type `show w`. This is free software, and you are welcome to redistribute it under certain conditions; type `show c` for details.

The hypothetical commands `show w` and `show c` should show the appropriate parts of the General Public License. Of course, the commands you use may be called something other than `show w` and `show c`; they could even be mouse-clicks or menu items—whatever suits your program.

You should also get your employer (if you work as a programmer) or your school, if any, to sign a “copyright disclaimer” for the program, if necessary. Here is a sample; alter the names:

Yoyodyne, Inc., hereby disclaims all copyright interest in the program `Gnomovision` (which makes passes at compilers) written by James Hacker.

<signature of Ty Coon>, 1 April 1989
Ty Coon, President of Vice

This General Public License does not permit incorporating your program into proprietary programs. If your program is a subroutine library, you may consider it more useful to permit linking proprietary applications with the library. If this is what you want to do, use the GNU Library General Public License instead of this License.

Appendix 12: GNU Lesser General Public License

GNU LESSER GENERAL PUBLIC LICENSE. Version 2.1, February 1999. Copyright © 1991, 1999 Free Software Foundation, Inc. 59 Temple Place, Suite 330, Boston, MA 02111-1307 USA. Everyone is permitted to copy and distribute verbatim copies of this license document, but changing it is not allowed. [This is the first released version of the Lesser GPL. It also counts as the successor of the GNU Library Public License, version 2, hence the version number 2.1.]

Preamble

The licenses for most software are designed to take away your freedom to share and change it. By contrast, the GNU General Public Licenses are intended to guarantee your freedom to share and change free software—to make sure the software is free for all its users.

This license, the Lesser General Public License, applies to some specially designated software packages—typically libraries—of the Free Software Foundation and other authors who decide to use it. You can use it too, but we suggest you first think carefully about whether this license or the ordinary General Public License is the better strategy to use in any particular case, based on the explanations below.

When we speak of free software, we are referring to freedom of use, not price. Our General Public Licenses are designed to make sure that you have the freedom to distribute copies of free software (and charge for this service if you wish); that you receive source code or can get it if you want it; that you can change the software and use pieces of it in new free programs; and that you are informed that you can do these things.

To protect your rights, we need to make restrictions that forbid distributors to deny you these rights or to ask you to surrender these rights. These restrictions translate to certain responsibilities for you if you distribute copies of the library or if you modify it.

For example, if you distribute copies of the library, whether gratis or for a fee, you must give the recipients all the rights that we gave you. You must make sure that they, too, receive or can get the source code. If you link other code with the library, you must provide complete object files to the recipients, so that they can relink them with the library after making changes to the library and recompiling it. And you must show them these terms so they know their rights. We protect your rights with a two-step method: (1) we copyright the library, and (2) we offer you this license, which gives you legal permission to copy, distribute and/or modify the library.

To protect each distributor, we want to make it very clear that there is no warranty for the free library. Also, if the library is modified by someone else and passed on, the recipients should know that what they have is not the original version, so that the original author's reputation will not be affected by problems that might be introduced by others.

Finally, software patents pose a constant threat to the existence of any free program. We wish to make sure that a company cannot effectively restrict the users of a free program by obtaining a restrictive license from a patent holder. Therefore, we insist that any patent license obtained for a version of the library must be consistent with the full freedom of use specified in this license.

Most GNU software, including some libraries, is covered by the ordinary GNU General Public License. This license, the GNU Lesser General Public License, applies to certain designated libraries, and is quite different from the ordinary General Public License. We use this license for certain libraries in order to permit linking those libraries into non-free programs.

When a program is linked with a library, whether statically or using a shared library, the combination of the two is legally speaking a combined work, a derivative of the original library. The ordinary General Public License therefore permits such linking only if the entire combination fits its criteria of freedom.

The Lesser General Public License permits more lax criteria for linking other code with the library.

We call this license the “Lesser” General Public License because it does Less to protect the user’s freedom than the ordinary General Public License. It also provides other free software developers Less of an advantage over competing non-free programs. These disadvantages are the reason we use the ordinary General Public License for many libraries. However, the Lesser license provides advantages in certain special circumstances.

For example, on rare occasions, there may be a special need to encourage the widest possible use of a certain library, so that it becomes a de-facto standard. To achieve this, non-free programs must be allowed to use the library. A more frequent case is that a free library does the same job as widely used non-free libraries. In this case, there is little to gain by limiting the free library to free software only, so we use the Lesser General Public License.

In other cases, permission to use a particular library in non-free programs enables a greater number of people to use a large body of free software. For example, permission to use the GNU C Library in non-free programs enables many more people to use the whole GNU operating system, as well as its variant, the GNU/Linux operating system.

Although the Lesser General Public License is Less protective of the users’ freedom, it does ensure that the user of a program that is linked with the Library has the freedom and the wherewithal to run that program using a modified version of the Library.

The precise terms and conditions for copying, distribution and modification follow. Pay close attention to the difference between a “work based on the library” and a “work that uses the library”. The former contains code derived from the library, whereas the latter must be combined with the library in order to run.

GNU LESSER GENERAL PUBLIC LICENSE. TERMS AND CONDITIONS FOR COPYING, DISTRIBUTION AND MODIFICATION

1. This License Agreement applies to any software library or other program which contains a notice placed by the copyright holder or other authorized party saying it may be distributed under the terms of this Lesser General Public License (also called “this License”). Each licensee is addressed as “you”.

A “library” means a collection of software functions and/or data prepared so as to be conveniently linked with application programs (which use some of those functions and data) to form executables.

The “Library”, below, refers to any such software library or work which has been distributed under these terms. A “work based on the Library” means either the Library or any derivative work under copyright law: that is to say, a work containing the Library or a portion of it, either verbatim or with modifications and/or translated straightforwardly into another language. (Hereinafter, translation is included without limitation in the term “modification”.)

“Source code” for a work means the preferred form of the work for making modifications to it. For a library, complete source code means all the source code for all modules it contains, plus any associated interface definition files, plus the scripts used to control compilation and installation of the library.

Activities other than copying, distribution and modification are not covered by this License; they are outside its scope. The act of running a program using the Library is not restricted, and output from such a program is covered only if its contents constitute a work based on the Library (independent of the use of the Library in a tool for writing it). Whether that is true depends on what the Library does and what the program that uses the Library does.

1. You may copy and distribute verbatim copies of the Library’s complete source code as you receive it, in any medium, provided that you conspicuously and appropriately publish on each copy an appropriate copyright notice and disclaimer of warranty; keep intact all the notices that refer to this License and to the absence of any warranty; and distribute a copy of this License along with the Library.

You may charge a fee for the physical act of transferring a copy, and you may at your option offer warranty protection in exchange for a fee.

2. You may modify your copy or copies of the Library or any portion of it, thus forming a work based on the Library, and copy and distribute such modifications or work under the terms of Section 1 above, provided that you also meet all of these conditions:

1. The modified work must itself be a software library.

b) You must cause the files modified to carry prominent notices stating that you changed the files and the date of any change.

c) You must cause the whole of the work to be licensed at no charge to all third parties under the terms of this License.

d) If a facility in the modified Library refers to a function or a table of data to be supplied by an application program that uses the facility, other than as an argument passed when the facility is invoked, then you must make a good faith effort to ensure that, in the event an application does not supply such function or table, the facility still operates, and performs whatever part of its purpose remains meaningful. (For example, a function in a library to compute square roots has a purpose that is entirely well-defined independent of the application. Therefore, Subsection 2d requires that any application-supplied function or table used by this function must be optional: if the application does not supply it, the square root function must still compute square roots.)

These requirements apply to the modified work as a whole. If identifiable sections of that work are not derived from the Library, and can be reasonably considered independent and separate works in themselves, then this License, and its terms, do not apply to those sections when you distribute them as separate works. But when you distribute the same sections as part of a whole which is a work based on the Library, the distribution of the whole must be on the terms of

this License, whose permissions for other licensees extend to the entire whole, and thus to each and every part regardless of who wrote it.

Thus, it is not the intent of this section to claim rights or contest your rights to work written entirely by you; rather, the intent is to exercise the right to control the distribution of derivative or collective works based on the Library.

In addition, mere aggregation of another work not based on the Library with the Library (or with a work based on the Library) on a volume of a storage or distribution medium does not bring the other work under the scope of this License.

3. You may opt to apply the terms of the ordinary GNU General Public License instead of this License to a given copy of the Library. To do this, you must alter all the notices that refer to this License, so that they refer to the ordinary GNU General Public License, version 2, instead of to this License. (If a newer version than version 2 of the ordinary GNU General Public License has appeared, then you can specify that version instead if you wish.) Do not make any other change in these notices.

Once this change is made in a given copy, it is irreversible for that copy, so the ordinary GNU General Public License applies to all subsequent copies and derivative works made from that copy.

This option is useful when you wish to copy part of the code of the Library into a program that is not a library.

4. You may copy and distribute the Library (or a portion or derivative of it, under Section 2) in object code or executable form under the terms of Sections 1 and 2 above provided that you accompany it with the complete corresponding machine-readable source code, which must be distributed under the terms of Sections 1 and 2 above on a medium customarily used for software interchange.

If distribution of object code is made by offering access to copy from a designated place, then offering equivalent access to copy the source code from the same place satisfies the requirement to distribute the source code, even though third parties are not compelled to copy the source along with the object code.

5. A program that contains no derivative of any portion of the Library, but is designed to work with the Library by being compiled or linked with it, is called a “work that uses the Library”. Such a work, in isolation, is not a derivative work of the Library, and therefore falls outside the scope of this License.

However, linking a “work that uses the Library” with the Library creates an executable that is a derivative of the Library (because it contains portions of the Library), rather than a “work that uses the library”. The executable is therefore covered by this License. Section 6 states terms for distribution of such executables.

When a “work that uses the Library” uses material from a header file that is part of the Library, the object code for the work may be a derivative work of the Library even though the source code is not. Whether this is true is especially significant if the work can be linked without the Library, or if the work is itself a library. The threshold for this to be true is not precisely defined by law.

If such an object file uses only numerical parameters, data structure layouts and accessors, and small macros and small inline functions (ten lines or less in length), then the use of the object file is unrestricted, regardless of whether it is legally a derivative work. (Executables containing this object code plus portions of the Library will still fall under Section 6.)

Otherwise, if the work is a derivative of the Library, you may distribute the object code for the work under the terms of Section 6. Any executables containing that work also fall under Section 6, whether or not they are linked directly with the Library itself.

6. As an exception to the Sections above, you may also combine or link a “work that uses the Library” with the Library to produce a work containing portions of the Library, and distribute that work under terms of your choice, provided that the terms permit modification of the work for the customer’s own use and reverse engineering for debugging such modifications.

You must give prominent notice with each copy of the work that the Library is used in it and that the Library and its use are covered by this License. You must supply a copy of this License. If the work during execution displays copyright notices, you must include

the copyright notice for the Library among them, as well as a reference directing the user to the copy of this License. Also, you must do one of these things:

1. Accompany the work with the complete corresponding machine-readable source code for the Library including whatever changes were used in the work (which must be distributed under Sections 1 and 2 above); and, if the work is an executable linked with the Library, with the complete machine-readable “work that uses the Library”, as object code and/or source code, so that the user can modify the Library and then relink to produce a modified executable containing the modified Library. (It is understood that the user who changes the contents of definitions files in the Library will not necessarily be able to recompile the application to use the modified definitions.)
 - b) Use a suitable shared library mechanism for linking with the Library. A suitable mechanism is one that (1) uses at run time a copy of the library already present on the user’s computer system, rather than copying library functions into the executable, and (2) will operate properly with a modified version of the library, if the user installs one, as long as the modified version is interface-compatible with the version that the work was made with.
 - c) Accompany the work with a written offer, valid for at least three years, to give the same user the materials specified in Subsection 6a, above, for a charge no more than the cost of performing this distribution.
 - d) If distribution of the work is made by offering access to copy from a designated place, offer equivalent access to copy the above specified materials from the same place.
 - e) Verify that the user has already received a copy of these materials or that you have already sent this user a copy.

For an executable, the required form of the “work that uses the Library” must include any data and utility programs needed for reproducing the executable from it. However, as a special exception, the materials to be distributed need not include anything that is normally distributed (in either source or binary form) with the major components (compiler, kernel, and so on) of the operating system on which the executable runs, unless that component itself accompanies the executable.

It may happen that this requirement contradicts the license restrictions of other proprietary libraries that do not normally accompany the operating system. Such a contradiction means you cannot use both them and the Library together in an executable that you distribute.

1. You may place library facilities that are a work based on the Library side-by-side in a single library together with other library facilities not covered by this License, and distribute such a combined library, provided that the separate distribution of the work based on the Library and of the other library facilities is otherwise permitted, and provided that you do these two things:
 1. Accompany the combined library with a copy of the same work based on the Library, uncombined with any other library facilities. This must be distributed under the terms of the Sections above.
 - b) Give prominent notice with the combined library of the fact that part of it is a work based on the Library, and explaining where to find the accompanying uncombined form of the same work.
1. You may not copy, modify, sublicense, link with, or distribute the Library except as expressly provided under this License. Any attempt otherwise to copy, modify, sublicense, link with, or distribute the Library is void, and will automatically terminate your rights under this License. However, parties who have received copies,

or rights, from you under this License will not have their licenses terminated so long as such parties remain in full compliance.

1. You are not required to accept this License, since you have not signed it. However, nothing else grants you permission to modify or distribute the Library or its derivative works. These actions are prohibited by law if you do not accept this License. Therefore, by modifying or distributing the Library (or any work based on the Library), you indicate your acceptance of this License to do so, and all its terms and conditions for copying, distributing or modifying the Library or works based on it.

10. Each time you redistribute the Library (or any work based on the Library), the recipient automatically receives a license from the original licensor to copy, distribute, link with or modify the Library subject to these terms and conditions. You may not impose any further restrictions on the recipients' exercise of the rights granted herein. You are not responsible for enforcing compliance by third parties with this License.

11. If, as a consequence of a court judgment or allegation of patent infringement or for any other reason (not limited to patent issues), conditions are imposed on you (whether by court order, agreement or otherwise) that contradict the conditions of this License, they do not excuse you from the conditions of this License. If you cannot distribute so as to satisfy simultaneously your obligations under this License and any other pertinent obligations, then as a consequence you may not distribute the Library at all. For example, if a patent license would not permit royalty-free redistribution of the Library by all those who receive copies directly or indirectly through you, then the only way you could satisfy both it and this License would be to refrain entirely from distribution of the Library.

If any portion of this section is held invalid or unenforceable under any particular circumstance, the balance of the section is intended to apply, and the section as a whole is intended to apply in other circumstances.

It is not the purpose of this section to induce you to infringe any patents or other property right claims or to contest validity of any such claims; this section has the sole purpose of protecting the integrity of the free software distribution system which is implemented by public license practices. Many people have made generous contributions to the wide range of software distributed through that system in reliance on consistent application of that system; it is up to the author/donor to decide if he or she is willing to distribute software through any other system and a licensee cannot impose that choice.

This section is intended to make thoroughly clear what is believed to be a consequence of the rest of this License.

12. If the distribution and/or use of the Library is restricted in certain countries either by patents or by copyrighted interfaces, the original copyright holder who places the Library under this License may add an explicit geographical distribution limitation excluding those countries, so that distribution is permitted only in or among countries not thus excluded. In such case, this License incorporates the limitation as if written in the body of this License.

13. The Free Software Foundation may publish revised and/or new versions of the Lesser General Public License from time to time. Such new versions will be similar in spirit to the present version, but may differ in detail to address new problems or concerns.

Each version is given a distinguishing version number. If the Library specifies a version number of this License which applies to it and “any later version”, you have the option of following the terms and conditions either of that version or of any later version published by the Free Software Foundation. If the Library does not specify a license version number, you may choose any version ever published by the Free Software Foundation.

14. If you wish to incorporate parts of the Library into other free programs whose distribution conditions are incompatible with these, write to the author to ask for permission. For software which is copyrighted by the Free Software Foundation, write to the Free Software Foundation; we sometimes make exceptions for this. Our decision will be guided by the two goals of preserving the free status of all derivatives of our free software and of promoting the sharing and reuse of software generally.

NO WARRANTY

15. BECAUSE THE LIBRARY IS LICENSED FREE OF CHARGE, THERE IS NO WARRANTY FOR THE LIBRARY, TO THE EXTENT PERMITTED BY APPLICABLE LAW. EXCEPT WHEN OTHERWISE STATED IN WRITING THE COPYRIGHT HOLDERS AND/OR OTHER PARTIES PROVIDE THE LIBRARY “AS IS” WITHOUT WARRANTY OF ANY KIND, EITHER EXPRESSED OR IMPLIED, INCLUDING, BUT NOT LIMITED TO, THE IMPLIED WARRANTIES OF MERCHANTABILITY AND FITNESS FOR A PARTICULAR PURPOSE. THE ENTIRE RISK AS TO THE QUALITY AND PERFORMANCE OF THE LIBRARY IS WITH YOU. SHOULD THE LIBRARY PROVE DEFECTIVE, YOU ASSUME THE COST OF ALL NECESSARY SERVICING, REPAIR OR CORRECTION.

16. IN NO EVENT UNLESS REQUIRED BY APPLICABLE LAW OR AGREED TO IN WRITING WILL ANY COPYRIGHT HOLDER, OR ANY OTHER PARTY WHO MAY MODIFY AND/OR REDISTRIBUTE THE LIBRARY AS PERMITTED ABOVE, BE LIABLE TO YOU FOR DAMAGES, INCLUDING ANY GENERAL, SPECIAL, INCIDENTAL OR CONSEQUENTIAL DAMAGES ARISING OUT OF THE USE OR INABILITY TO USE THE LIBRARY (INCLUDING BUT NOT LIMITED TO LOSS OF DATA OR DATA BEING RENDERED INACCURATE OR LOSSES SUSTAINED BY YOU OR THIRD PARTIES OR A FAILURE OF THE LIBRARY TO OPERATE WITH ANY OTHER SOFTWARE), EVEN IF SUCH HOLDER OR OTHER PARTY HAS BEEN ADVISED OF THE POSSIBILITY OF SUCH DAMAGES.

END OF TERMS AND CONDITIONS

How to Apply These Terms to Your New Libraries

If you develop a new library, and you want it to be of the greatest possible use to the public, we recommend making it free software that everyone can redistribute and change. You can do so by permitting redistribution under these terms (or, alternatively, under the terms of the ordinary General Public License). To apply these terms, attach the following notices to the library. It is safest to attach them to the start of each source file to most effectively convey the exclusion of warranty; and each file should have at least the “copyright” line and a pointer to where the full notice is found.

```
<one line to give the library's name and a brief idea of what it does.>
Copyright © <year> <name of author>
```

This library is free software; you can redistribute it and/or modify it under the terms of the GNU Lesser General Public License as published by the Free Software Foundation; either version 2.1 of the License, or (at your option) any later version. This library is distributed in the hope that it will be useful, but WITHOUT ANY WARRANTY; without even the implied warranty of MERCHANTABILITY or FITNESS FOR A PARTICULAR PURPOSE.

See the GNU Lesser General Public License for more details. You should have received a copy of the GNU Lesser General Public License along with this library; if not, write to the Free Software Foundation, Inc., 59 Temple Place, Suite 330, Boston, MA 02111-1307 USA

Also add information on how to contact you by electronic and paper mail. You should also get your employer (if you work as a programmer) or your school, if any, to sign a

“copyright disclaimer” for the library, if necessary. Here is a sample; alter the names:

Yoyodyne, Inc., hereby disclaims all copyright interest in the library `Frob' (a library for tweaking knobs) written by James Random Hacker.

<signature of Ty Coon>, 1 April 1990

Ty Coon, President of Vice

List of Figures

Figure 1: Evaluation Board EVA4 with PNP/1110	7
Figure 2: Main components of the Evaluation Board DNP/EVA4.....	8
Figure 3: Position of the DIL/NetPC on the Evaluation Board	12
Figure 4: Overview about the required cable Connections	13
Figure 5: Serial Link Connection	13
Figure 6: Ethernet Link Connection	14
Figure 7: Power supply Connection.....	14
Figure 8: LC-Display Connection	15
Figure 9: Interface property Sheet	16
Figure 10: Baud rate Settings	17
Figure 11: DIL/NetPC boot Process	18
Figure 12: Communication check via PING	18
Figure 13: Communication check via ipconfig command	19
Figure 14: Web page shown by the MS-Internet Explorer	19
Figure 15: Login procedure via HyperTerminal.....	20
Figure 16: Login procedure via Telnet	21
Figure 17: Login procedure via FTP.....	22
Figure 18: FTP file transfer under DOS.....	22
Figure 19: File transfer with the Internet Explorer	23
Figure 20: Boot Procedure	24
Figure 21: Flash Loader Messages	24
Figure 22: Flash Loader file Select.....	25
Figure 23: Serial Port Settings under Minicom	26
Figure 24: Boot Procedure	26
Figure 25: Login Request.....	27
Figure 26: Ping Request.....	27
Figure 27: IP-address check via ifconfig	28
Figure 28: Web page shown by the Konqueror File Manager	28
Figure 29: Login procedure via Minicom	29
Figure 30: Login procedure via Telnet	29
Figure 31: Login procedure via FTP.....	30
Figure 32: File transfer with Minicom.....	31
Figure 33: File transfer with the Konqueror.....	31
Figure 34: Boot Procedure	32
Figure 35: Flash Loader Messages	33
Figure 36: Transfer method Select	33
Figure 37: Transmission file Select	34
Figure 38: Transmission Status	34
Figure 39: Location of the tar-archive on the Starter Kit CD-ROM.....	35

Figure 40: Unpacking the tar-Archive	36
Figure 41: A simple C-Program	36
Figure 42: C-source code Compiling.....	37
Figure 43: File transfer with FTP	38
Figure 44: Telnet Session.....	38
Figure 45: PNP/1110 Pin Side View	41
Figure 46: Interrupt Usage.....	51
Figure 47: RCME Jumper	52
Figure 48: PNP/1110 Clock Output.....	52
Figure 49: PNP/1110 Serial Channels	53
Figure 50: PNP/1110 CF-Interface Connection	54
Figure 51: PNP/1110 Decoder Logic Connection	55
Figure 52: Dimensions of the PNP/1110	57

List of Tables

Table 1: Convention usage.....	5
Table 2: Pin assignment PNP/1110 pin A1 to A17	41
Table 3: Pin assignment PNP/1110 pin B1 to B17	42
Table 4: Pin assignment PNP/1110 pin C1 to C17.....	42
Table 5: Pin assignment PNP/1110 pin D1 to D17	42
Table 6: Pin assignment PNP/1110 pin E1 to E17	43
Table 7: Pin assignment PNP/1110 pin F1 to F17.....	43
Table 8: Pin assignment PNP/1110 pin G1 to G17	43
Table 9: Pin assignment PNP/1110 pin H1 to H17	43
Table 10: Pin assignment PNP/1110 pin J1 to J17	44
Table 11: Pin assignment PNP/1110 pin K1 to K17.....	44
Table 12: Pin assignment PNP/1110 pin L1 to L17	44
Table 13: Pin assignment PNP/1110 pin M1 to M17	44
Table 14: Pin assignment PNP/1110 pin N1 to N17.....	45
Table 15: Pin assignment PNP/1110 pin P1 to P17.....	45
Table 16: Pin assignment PNP/1110 pin Q1 to Q17.....	45
Table 17: Pin assignment PNP/1110 pin R1 to R17.....	46
Table 18: Pin assignment PNP/1110 pin S1 to S17.....	46
Table 19: Pinout CFL Connector.....	47
Table 20: Pinout LCD Connector	47
Table 21: Pinout COM1 Connector	48
Table 22: Pinout COM2 Connector	48
Table 23: Pinout 10/100 Mbps Connector	48
Table 24: Pinout JTAG Connector	49
Table 25: Pinout Power Connector	49

Table 26: RCM Jumper Settings	49
Table 27: Pinout Power Connector	49
Table 28: PNP/1110 Memory Map	50
Table 29: DIP-Switch Settings	50
Table 30: Interrupt Usage	51
Table 31: CF-Interface Pin Connections	54
Table 32: CF-Interface Power/GND Connections	55
Table 32: Decoder Characteristics	56

List of Appendixes

Appendix 1: Pin Assignment PNP/1110	41
Appendix 2: Pin Assignment DNP/EVA4 Components	47
Appendix 3: PNP/1110 Memory Map	50
Appendix 4: DIP-Switch Settings	50
Appendix 5: Interrupt Usage	51
Appendix 6: The RCME (RCM Enable) Jumper	52
Appendix 7: The PNP/1110 Clock Output	52
Appendix 8: Using the SA-1110 Serial Channels	53
Appendix 9: Using the Compact Flash (CF)-Interface	54
Appendix 11: GNU General Public License	58
Appendix 12: GNU Lesser General Public License	63
List of Figures	71
List of Tables	72
List of Appendixes	73
Contact	74
Document History	74

Contact

SSV Embedded Systems
Heisterbergallee 72
D-30453 Hannover
Tel. +49-(0)511-40000-0
Fax. +49-(0)511-40000-40
E-Mail: sales@ist1.de
Internet: www.ssv-embedded.de

Document History

Revision	Date		Name
1.0	28.08.2002	First Version	JNE
1.1	25.09.2002	SA-1110 corresponding pins added, Appendixes 5..7 added	JNE
1.2	3.12.2002	Some Appendixes added	JNE
1.3	6.12.2002	Some corrections in chapter 5.2.9	JNE

This document is written only for the internal application. The contents of this document can change any time without announcement. There is taken over no guarantee for the accuracy of the statements. Copyright © **SSV EMBEDDED SYSTEMS 2002**. All rights reserved.

INFORMATION PROVIDED IN THIS DOCUMENT IS PROVIDED 'AS IS' WITHOUT WARRANTY OF ANY KIND. The user assumes the entire risk as to the accuracy and the use of this document. Some names within this document can be trademarks of their respective holders.