

E2U/ESL1

Board Revision 1.0

Hardware Reference

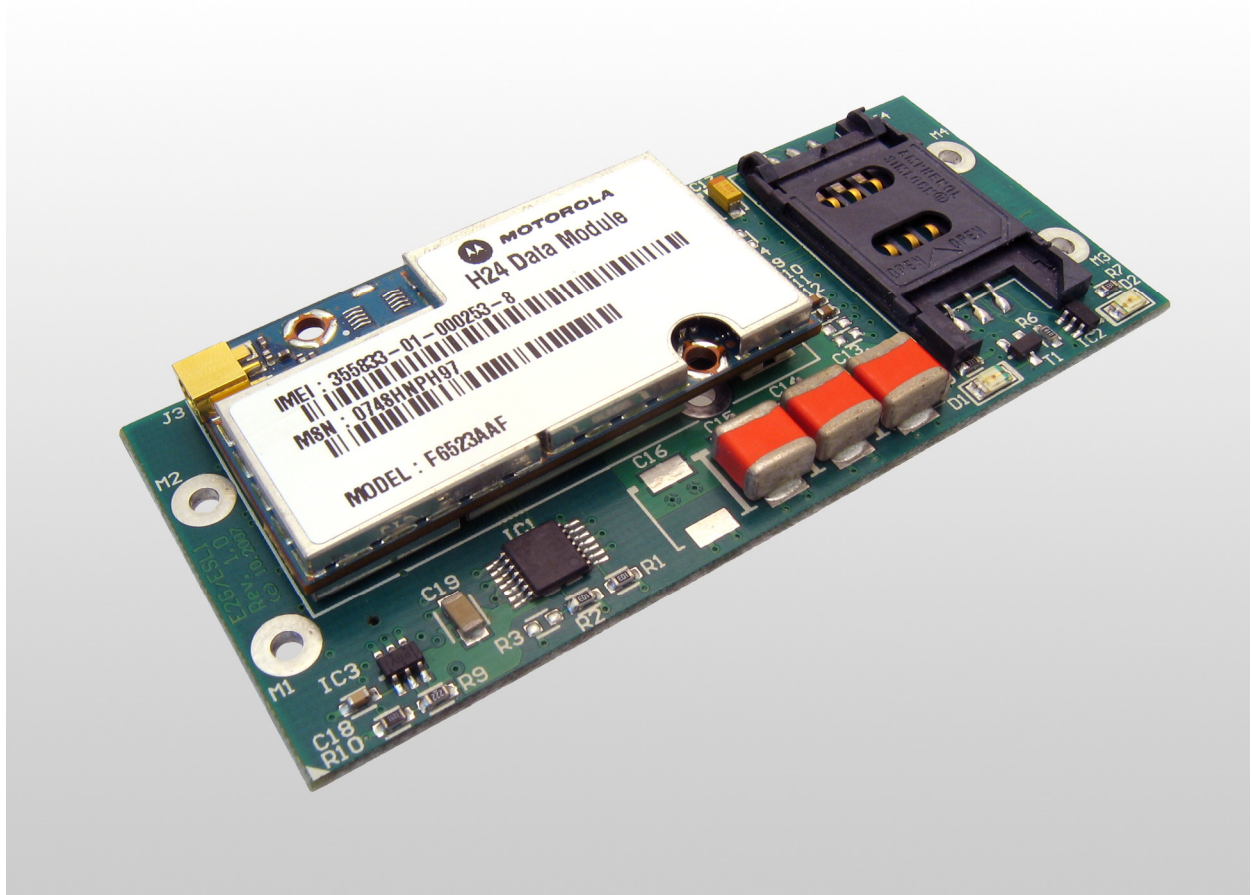

SSV Embedded Systems

Dünenweg 5
D-30419 Hannover
Phone: +49 (0)511/40 000-0
Fax: +49 (0)511/40 000-40
E-mail: sales@ssv-embedded.de

Document Revision: 1.0
Date: 2010-02-19

CONTENT

1	INTRODUCTION	3
1.1	Safety Guidelines	3
1.2	Block Diagram	3
1.3	Feature Overview	4
2	BOARD LAYOUT	5
3	PINOUTS	6
3.1	80-pin ESL Connector (1. Part)	6
3.2	80-pin ESL Connector (2. Part)	7
3.3	SIM Card Holder	8
4	MECHANICAL DIMENSIONS	9
5	HELPFUL LITERATURE	10
	CONTACT	10
	DOCUMENT HISTORY	10

1 INTRODUCTION

This document describes the hardware components of the E2U/ESL1. For further information about the individual components of this product you may follow the links from our website at <http://www.ssv-embedded.de>. Our website contains a lot of technical information, which will be updated in regular periods.

1.1 Safety Guidelines

Please read the following safety guidelines carefully! In case of property or personal damage by not paying attention to this document and/or by incorrect handling, we do not assume liability. In such cases any warranty claim expires.



ATTENTION: Observe precautions for handling – electrostatic sensitive device!

- Discharge yourself before you work with the device, e.g. by touching a heater of metal, to avoid damages.
- Stay grounded while working with the device to avoid damage through electrostatic discharge.

1.2 Block Diagram

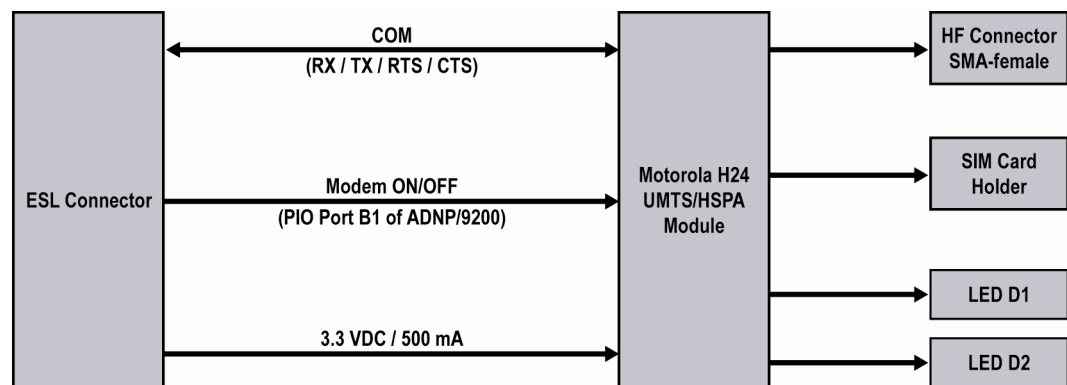

Figure 1: Block diagram of E2U/ESL1

The Modem ON/OFF signal is set high, when a power supply is applied to the H24. To turn the H24 on, set the signal level low for min. 500 ms and max. 1500 ms. To turn the H24 off, set the signal level low for min. 2000 ms.

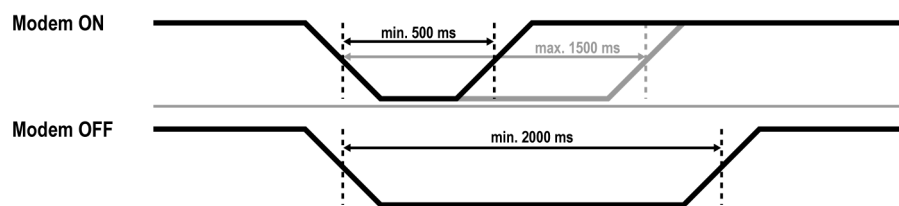

Figure 2: Turning the H24 on and off

1.3 Feature Overview

- 80-pin ESL connector as interface to the DIL/NetPC ADNP/9200
- Serial interface to ADNP/9200 COM2 port for modem setup operations
- User setup over serial interface from ADNP/9200 Linux command line
- Motorola H24 UMTS module
- Quad Band GSM 850/900/1800/1900 MHz
- GSM/GPRS/ 3GPP Release 9
- Coding scheme: CS1-CS4
- EDGE Multi-slot class 12
- Coding scheme: MCS1-MCS9
- UMTS/HSPA Single Band 2100 MHz
- UMTS/HSDPA/HSUPA 3GPP Release 6
- Max uplink 5.76 Mbps
- Max downlink 7.2 Mbps
- UE CAT[1-8], 11, 12 supported
- Compressed mode (3GPP TS25.212)
- CSD: max. 14.4 Kbps
- SMS: MO/MT text and PDU operating modes
- Fax: class 1
- AT command set: GSM 07.05, GSM 07.07, GSM 07.10
- AT command expansions: Motorola/Telit-specific
- 2x status LEDs (GPRS network connection, modem activity)
- 3.3 VDC / 500 mA (max.) power supply
- Operating temperature 0° to +70° C
- Module size 82 mm x 36 mm

2 BOARD LAYOUT

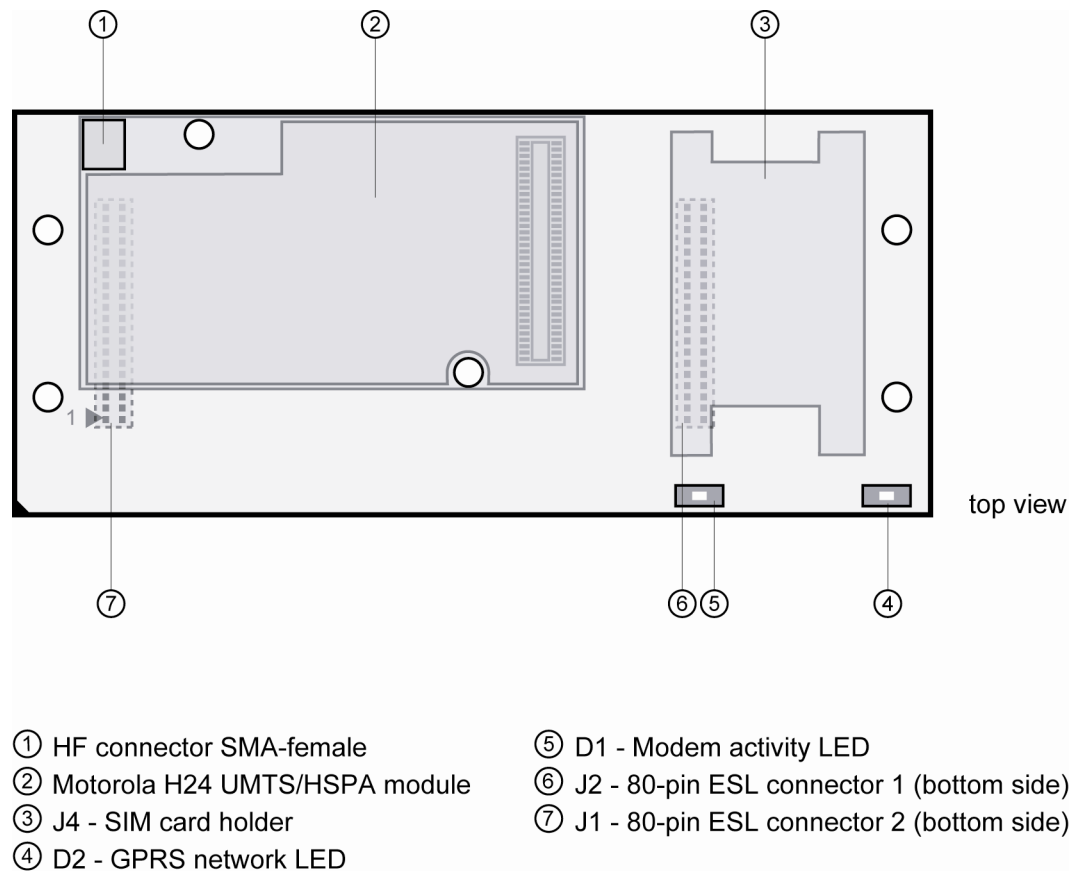

Figure 3: Board layout E2U/ESL1

3 PINOUTS

3.1 80-pin ESL Connector (1. Part)

Pin	Name	Function
1	VCC	3.3 Volt Power Input
2	GND	Ground
3	---	Reserved – Do not use
4	---	Reserved – Do not use
5	---	Reserved – Do not use
6	---	Reserved – Do not use
7	VCC	3.3 Volt Power Input
8	GND	Ground
9	---	Reserved – Do not use
10	---	Reserved – Do not use
11	---	Reserved – Do not use
12	---	Reserved – Do not use
13	---	Reserved – Do not use
14	---	Reserved – Do not use
15	---	Reserved – Do not use
16	---	Reserved – Do not use
17	GND	Ground
18	VCC	3.3 Volt Power Input
19	---	Reserved – Do not use
20	RTS	Serial Port, RTS Pin
21	---	Reserved – Do not use
22	TXD	Serial Port, TXD Pin
23	---	Reserved – Do not use
24	RXD	Serial Port, RXD Pin
25	---	Reserved – Do not use
26	CTS	Serial Port, CTS Pin
27	GND	Ground
28	VCC	3.3 Volt Power Input
29	---	Reserved – Do not use
30	ONOFF	Modem On / Off (PIO PB1 of ADNP/9200)
31	---	Reserved – Do not use
32	---	Reserved – Do not use
33	---	Reserved – Do not use
34	---	Reserved – Do not use
35	---	Reserved – Do not use
36	---	Reserved – Do not use
37	GND	Ground
38	GND	Ground
39	VCC	3.3 Volt Power Input
40	VCC	3.3 Volt Power Input

Table 1: 80-pin ESL connector pinout – pin 1 to 40

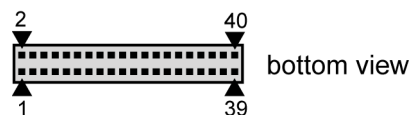

3.2 80-pin ESL Connector (2. Part)

Pin	Name	Function
41	VCC	3.3 Volt Power Input
42	VCC	3.3 Volt Power Input
43	GND	Ground
44	GND	Ground
45	---	Reserved – Do not use
46	---	Reserved – Do not use
47	---	Reserved – Do not use
48	---	Reserved – Do not use
49	GND	Ground
50	GND	Ground
51	---	Reserved – Do not use
52	RESET#	Reset
53	VCC	3.3 Volt Power Input
54	GND	Ground
55	---	Reserved – Do not use
56	---	Reserved – Do not use
57	---	Reserved – Do not use
58	---	Reserved – Do not use
59	---	Reserved – Do not use
60	---	Reserved – Do not use
61	---	Reserved – Do not use
62	---	Reserved – Do not use
63	VCC	3.3 Volt Power Input
64	GND	Ground
65	---	Reserved – Do not use
66	---	Reserved – Do not use
67	---	Reserved – Do not use
68	---	Reserved – Do not use
69	---	Reserved – Do not use
70	---	Reserved – Do not use
71	---	Reserved – Do not use
72	---	Reserved – Do not use
73	GND	Ground
74	VCC	3.3 Volt Power Input
75	---	Reserved – Do not use
76	---	Reserved – Do not use
77	---	Reserved – Do not use
78	---	Reserved – Do not use
79	GND	Ground
80	VCC	3.3 Volt Power Input

Table 2: 80-pin ESL connector pinout – pin 41 to 80

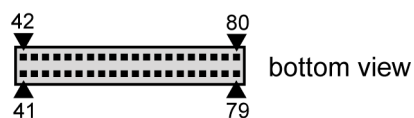

3.3 SIM Card Holder

Pin	Name	Function
1	SIMVCC	SIM Card VCC
2	SIMRES	SIM Card Reset
3	SIMCLK	SIM Card Clock
4	SIMGND	SIM Card Ground
5	---	Not Connected
6	SIMDAT	SIM Card Data

Table 3: SIM card holder pinout



4 MECHANICAL DIMENSIONS

All length dimensions have a tolerance of 0.5 mm. The drillings are suitable for M2.2 screws.

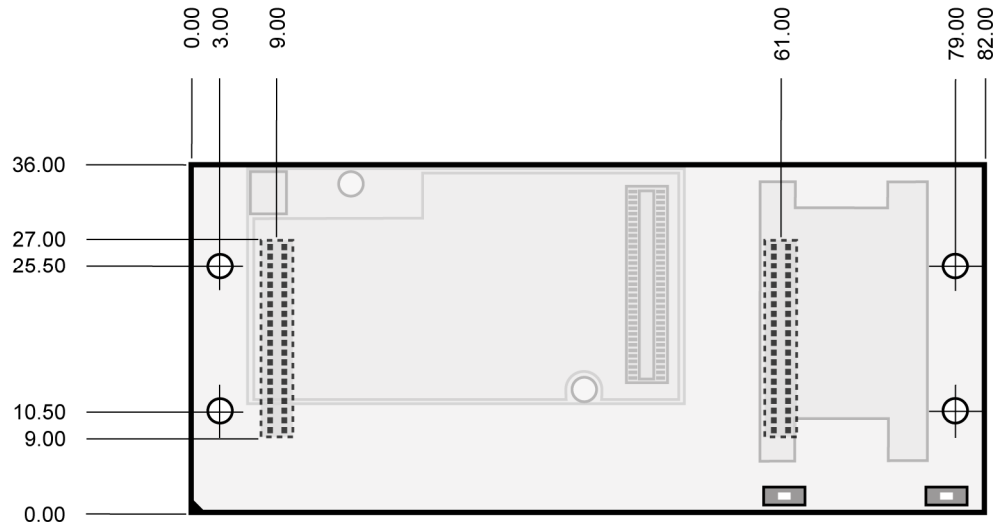

Figure 4: Mechanical dimensions of E2U/ESL1

ESL connector specifications:

2x 40-pin Samtec FTMH-120-03-F-DV-ES connectors (18 mm x 5 mm)

GSM/GPRS module connector specifications:

2x 35-pin Molex 52991-0708 connector

5 HELPFUL LITERATURE

- DIL/NetPC ADNP/9200 hardware reference manual
- Evaluation Board DNP/EVA11 hardware reference manual
- First Steps Starter Kit DNP/SK27
- Datasheet UMTS/HSPA module: Motorola H24 hardware description

CONTACT

SSV Embedded Systems

Dünenweg 5

D-30419 Hannover

Phone: +49 (0)511/40 000-0

Fax: +49 (0)511/40 000-40

E-mail: sales@ssv-embedded.de

Internet: www.ssv-embedded.de

Support: www.ssv-comm.de/forum

For actual information about the E2U/ESL1 visit us at www.dilnetpc.com.

DOCUMENT HISTORY

Revision	Date	Remarks	Name
1.0	2010-02-19	first version	WBU

The content of this document can change any time without announcement. There is taken over no guarantee for the accuracy of the statements. The user assumes the entire risk as to the accuracy and the use of this document. Information in this document is provided 'as is' without warranty of any kind. Some names within this document can be trademarks of their respective holders.

© 2010 SSV EMBEDDED SYSTEMS. All rights reserved.